

Balflex®



**BW -
MULTI CRIMP
SERIES ONE PIECE,
NO SKIVE HYDRAULIC
FITTINGS CATALOG
2021**

European Technology

*Established since 1963, **Balflex®** is a European international group of companies dedicated to the design, production, assembly and distribution of all types of high-tech products for conduction of fluids, measuring of pressure and power transmission at very high quality level.*

*58 years of know-how and expertise in this field, makes **Balflex®** the first choice for the mining, agriculture, off-shore and construction industries.*

*Today the **Balflex®** Group covers worldwide users through our own company's production facilities, branches and net of certified distributors.*

Balflex® valorizes the inside meaning of the words we use: **Excellence** the quality of being outstanding; **Innovation** the action or process of innovating; **Partnership** cooperation relationship between two or more people, having in mind a common goal; **Tradition** way of thinking or acting, inherited from previous generations.





Quality

Quality is very important for us. We have fully equipped, modern laboratories and equipment, employing the industries most experienced personnel.

Balflex® has earned various certifications for our Management Systems and Products. This reliable and consistent approach has allowed us to achieve our ISO 9001:2015 certification. At Balflex® quality and service always comes first. We are dedicated to continue the development of new products with a strong emphasis on quality.

Member of:



Certified by:



Hose Fittings Pressure Ratings

For each type of fitting there is a maximum working pressure recommended in table below. Whenever information is not available, contact the manufacturer.

Inch Fittings (size)													
Maximum Working pressure (MPa/psi) – safety factor 4:1													
Description	Part Number	-2	-3	-4	-5	-6	-8	-10	-12	-16	-20	-24	-32
NPTF Male	XX.0400 XX.0410 XX.0490	34.5 5000		27.6 4000		20.7 3000	20.7 3000		17.2 2500	13.8 2000	7.9 1150	6.9 1000	6.9 1000
BSP Male	XX.0100	42.0 6090		45.0 6525		40.0 5800	40.0 5800	40.0 5800	38.0 5510	34.5 5003	24.0 3480	21.0 3045	17.2 2494
BSP Swivel Female	XX.3012 XX.3042 XX.3092	42.0 6090		45.0 6525		40.0 5800	40.0 5800	40.0 5800	38.0 5510	34.5 5003	24.0 3480	21.0 3045	17.2 2494
BSP Swivel Female with O-ring	XX.3112 XX.3142 XX.3192			45.0 6525		40.0 5800	40.0 5800	40.0 5800	38.0 5510	34.5 5003	24.0 3480	21.0 3045	17.2 2494
JIC 37° Male	XX.2000			35.0 5075	35.0 5075	35.0 5075	31.0 4495	24.0 3480	24.0 3480	21.0 3045	17.0 2465	14.0 2030	10.5 1523
JIC 37° Swivel Female	XX.4012 XX.4042 XX.4092 XX.4H12			35.0 5075	35.0 5075	35.0 5075	31.0 4495	24.0 3480	24.0 3480	21.0 3045	17.0 2465	14.0 2030	10.5 1523
Flange 3000 PSI	XX.7013 XX.7043 XX.7093						34.5 5000	34.5 5000	34.5 5000	34.5 5000	27.6 4000	20.7 3000	17.2 2500
Flange 6000 PSI	XX.7016 XX.7046 XX.7096						41.4 6000	41.4 6000		41.4 6000	41.4 6000	41.4 6000	41.4 6000
ORFS Male	XX.4000			63.0 9135		63.0 9135	63.0 9135	40.0 5800	40.0 5800	40.0 5800	25.0 3625	25.0 3625	
ORFS Female	XX.4414 XX.4444 XX.4494 XX.44H4			63.0 9135		63.0 9135	63.0 9135	40.0 5800	40.0 5800	40.0 5800	25.0 3625	25.0 3625	

The Working Pressure of the hose assembly shall be the lower of the pressures given for its sizes in the fittings standards and in the the relevant hose specification.



Metric Tube (mm) – Light Serie "L"											
Maximum Working pressure (MPa/psi) – safety factor 4:1											
Description	Part Number	6	8	10	12	15	18	22	28	35	42
Metric Male	XX.1000	25.0 3625	25.0 3625	25.0 3625	25.0 3625	25.0 3625	16.0 2320	16.0 2320	10.0 1450	10.0 1450	10.0 1450
Metric Swivel Female with O-ring	XX.5013 XX.5043 XX.5093	25.0 3625	25.0 3625	25.0 3625	25.0 3625	25.0 3625	16.0 2320	16.0 2320	10.0 1450	10.0 1450	10.0 1450

Metric Tube (mm) – Heavy Serie "S"											
Maximum Working pressure (MPa/psi) – safety factor 4:1											
Description	Part Number	6	8	10	12	14	16	20	25	30	38
Metric Male	XX.1100	63.0 9135	63.0 9135	63.0 9135	63.0 9135	63.0 9135	40.0 5800	40.0 5800	40.0 5800	25.0 3625	25.0 3625
Metric Swivel Female with O-ring	XX.5113 XX.5143 XX.5193	63.0 9135	63.0 9135	63.0 9135	63.0 9135	63.0 9135	40.0 5800	40.0 5800	40.0 5800	25.0 3625	25.0 3625

The Working Pressure of the hose assembly shall be the lower of the pressures given for its sizes in the fittings standards and in the the relevant hose specification.

With our thick Zinc coating, Cr-VI free zinc plating process, a high corrosion resistance on all our carbon steel products is achieved, in compliance with EU and USA regulation, as well as with all relevant fitting standards, such as SAE J516 and DIN EN ISO 12151.

Due to exclusion of hexavalent chromium, we assure an environment friendly final product, without compromising the corrosion resistance.

Our zinc-plating when tested according to EN ISO 9227 guarantees minimum 240 hours, before appearance of corrosion.

(The presented values are measured before crimping operation)

The Correct Method to Fit Female Swivel Ends

To ensure a leakproof seal between swivel female hose ends shown in this catalogue and the appropriate adaptors it is necessary to follow the procedure below which is different from hydraulic tube assembly (This instruction is not valid for ORFS fittings).

Metal-to-metal seal

Screw the nut up hand tight and then with a spanner for one further 1/4 turn only.

Soft seal by O-ring

Screw the nut up hand tight and then with a spanner for one further 1/4 turn only.



Ensure that in all cases the hose is correctly aligned before tightening the nut onto the corresponding adaptor.

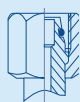

Spanner Torque Values

Metric swivel female			
 Thread Metric	Tube O.D.	Nm	
		nominal	min. - max.
M 12x1,5	06L	16	15 - 17
M 14x1,5	08L	16	15 - 17
M 16x1,5	10L	26	25 - 28
M 18x1,5	12L	37	35 - 39
M 22x1,5	15L	47	45 - 50
M 26x1,5	18L	89	85 - 94
M 30x2	22L	116	110 - 121
M 36x2	28L	137	130 - 143
M 45x2	35L	226	215 - 237
M 52x2	42L	347	330 - 363
M 14x1,5	06S	26	25 - 28
M 16x1,5	08S	42	40 - 44
M 18x1,5	10S	53	50 - 55
M 20x1,5	12S	63	60 - 66
M 22x1,5	14S	79	75 - 83
M 24x1,5	16S	84	80 - 88
M 30x2	20S	126	120 - 132
M 36x2	25S	179	170 - 187
M 42x2	30S	263	250 - 275
M 52x2	38S	368	350 - 385

BSP swivel female			
 Thread BSPP	Size	Nm	
		style A	style B
G1/8	-2	-	10
G1/4	-4	20	20
G3/8	-6	35	35
G1/2	-8	50	60
G5/8	-10	60	70
G3/4	-12	85	115
G1	-16	115	140
G1.1/4	-20	190	210
G1.1/2	-24	240	290
G2	-32	300	400



JIC 37° Swivel Female		
		
Thread UNF	Size	Nm +10% -0%
7/16-20	-4	15
1/2-20	-5	19
9/16-18	-6	24
3/4-16	-8	49
7/8-14	-10	77
1.1/16-12	-12	107
1.5/16-12	-16	147
1.5/8-12	-20	172
1.7/8-12	-24	215
2.1/2-12	-32	332

ORFS Swivel Female		
		
Thread UNF	Size	Nm +10% -0%
9/16-18	-4	25
11/16-18	-6	40
13/16-16	-8	55
1-14	-10	60
1.3/16-12	-12	90
1.5/16-12	-14	115
1.7/16-12	-16	125
1.11/16-12	-20	170
2-12	-24	200

The torque values for other materials are as follows:

- **Brass fittings and adapters**
65% of the torque value for steel.
- **Stainless steel**
use high side of the torque range for steel.
threads to be lubricated for these materials.
- **Dissimilar metals**
use torque value designated for the lower of the two materials.
- **All fittings are dry except as noted above.**

Note

Values given in tables are typical to achieve the recommended assembly methods when fitting material is steel zinc plated. For other materials different values will be applicable.

Quick identification of hydraulic connectors

DIN 24° light (L) and heavy series (S) with O-ring

The male has a 24° sealing angle cone seat with straight metric threads. The female has a 24° convex cone with O-ring and a swivel straight metric threaded nut.

Standard: ISO 12151-2, ISO 8434-1, ISO 8434-4

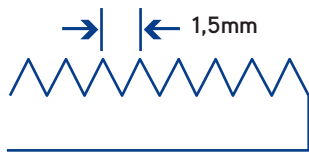
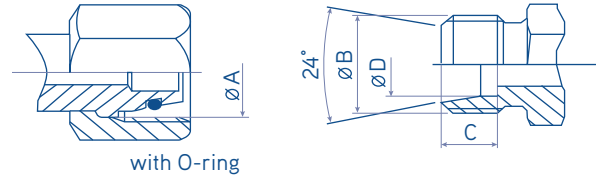

Thread

Defined by the outside diameter and the pitch (distance between 2 crests of the thread)
example: M22x1.5 - pitch of 1.5mm.

Tube O.D. (mm)	Tube type	Thread metric	ØA (mm)	ØB (mm)	C (mm)	ØD (mm)
6.00	6L	M12x1.5	10.50	12.00	7.00	6.00
6.00	6S	M14x1.5	12.50	14.00	7.00	6.00
8.00	8L	M14x1.5	12.50	14.00	7.00	8.00
8.00	8S	M16x1.5	14.50	16.00	7.00	8.00
10.00	10L	M16x1.5	14.50	16.00	7.00	10.00
10.00	10S	M18x1.5	16.50	18.00	7.50	10.00
12.00	12L	M18x1.5	16.50	18.00	7.00	12.00
12.00	12S	M20x1.5	18.50	20.00	7.50	12.00
14.00	14S	M22x1.5	20.50	22.00	8.00	14.00
15.00	15L	M22x1.5	20.50	22.00	7.00	15.00
16.00	16S	M24x1.5	22.50	24.00	8.50	16.00
18.00	18L	M26x1.5	24.50	26.00	7.50	18.00
20.00	20S	M30x2.0	27.90	30.00	10.50	20.00
22.00	22L	M30x2.0	27.90	30.00	7.50	22.00
25.00	25S	M36x2.0	33.90	36.00	12.00	25.00
28.00	28L	M36x2.0	33.90	36.00	7.50	28.00
30.00	30S	M42x2.0	39.90	42.00	13.50	30.00
35.00	35L	M45x2.0	42.90	45.00	10.50	35.00
38.00	38S	M52x2.0	49.90	52.00	16.00	38.00
42.00	42L	M52x2.0	49.90	52.00	11.00	42.00



British Standard Pipe Parallel (BSPP)

Referred to as Whitworth threads, the BSP thread type fittings seal use metal-to-metal angled surfaces or a combination of metal-to-metal and an O-ring. The angle of the sealing surfaces is 60° for both forms. Standard: BS 5200 ISO 12151-6

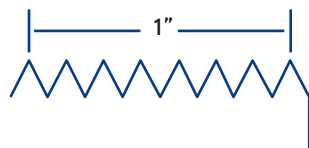
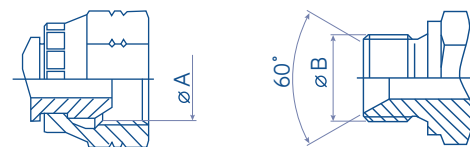

Thread

Identification is made by measuring the outside diameter of the thread and the number of threads per inch (25.4mm).

Tube I.D. (mm)	Tube O.D. (mm)	Size	Thread BSP	ØA (mm)	ØB (mm)
6	10	- 2	1/8" -28	8.60	9.70
8	13	- 4	1/4" -19	11.50	13.20
12	17	- 6	3/8" -19	14.90	16.70
15	21	- 8	1/2" -14	18.60	20.90
18	23	- 10	5/8" -14	20.60	22.90
20	27	- 12	3/4" -14	24.10	26.40
26	34	- 16	1" -11	30.30	33.20
33	42	- 20	1.1/4" -11	38.90	41.90
40	49	- 24	1.1/2" -11	44.90	47.80
50	60	- 32	2" -11	56.70	59.60

British Standard Pipe Tapered (BSPT)

Fittings seal through the thread interface mechanism. Care should be taken not to confuse the BSPT fitting with the NPTF male fitting. BSPT has a 55° thread angle.

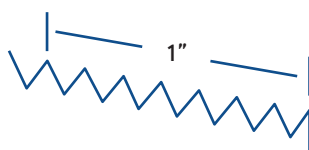
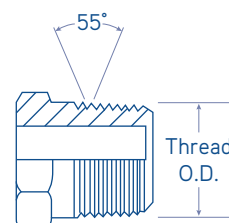

Thread

Identification is made by measuring the outside diameter of the thread and the number of threads per inch (25.4mm).

Tube I.D. (mm)	Tube O.D. (mm)	Size	Thread BSPT	ØA (mm)
5	10	- 2	1/8" -28	9.73
8	13	- 4	1/4" -19	13.16
12	17	- 6	3/8" -19	16.66
15	21	- 8	1/2" -14	20.96
20	27	- 12	3/4" -14	26.44
26	34	- 16	1" -11	33.25
33	42	- 20	1.1/4" -11	41.91
40	49	- 24	1.1/2" -11	47.80
50	60	- 32	2" -11	59.61
50	60	- 32	2" -11	56.70

BSP Flat Seal

These fittings have BSP parallel threads but the sealing surface is flat. The seal is made when the composite seal is compressed against the female flat face.

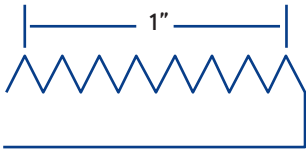
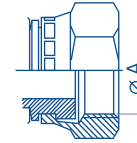

Thread

Identification is made by measuring the outside diameter of the thread and the number of threads per inch (25.4mm).

Tube I.D. (mm)	Tube O.D. (mm)	Size	Thread BSPT	ØA (mm)
6	10	- 2	1/8" -28	8.60
8	13	- 4	1/4" -19	11.50
12	17	- 6	3/8" -19	14.90
15	21	- 8	1/2" -14	18.60
18	23	- 12	5/8" -14	20.60
20	27	- 16	3/4" -14	24.10
26	34	- 20	1" -11	30.30
33	42	- 20	1.1/4" -11	38.90
40	49	- 24	1.1/2" -11	44.90
50	60	- 32	2" -11	56.70

Dry Seal American Standard Taper Pipe Thread (NPTF)

This type of fitting uses the thread interface to seal and as such has a tapered thread that deforms and forms the seal. They have 30° sealing angle surfaces, forming a 60° inverted (concave) seat.

Standard: SAE J476 / ANSI/ASME B1.20.1

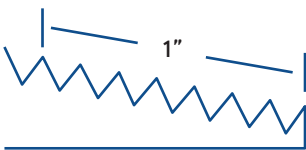
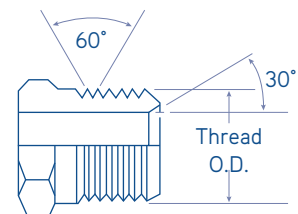

Thread

Identification is made by measuring the outside diameter of the thread and the number of threads per inch (25.4mm).

Size	Thread NPTF	ØA (mm)
- 2	1/8" -27	10.24
- 4	1/4" -18	13.61
- 6	3/8" -18	17.05
- 8	1/2" -14	21.22
- 12	3/4" -14	26.56
- 16	1" -11.5	33.22
- 20	1.1/4" -11.5	41.98
- 24	1.1/2" -11.5	48.05
- 32	2" -11.5	60.09



SAE JIC 37°

Commonly referred to as JIC fittings, these metal-to-metal sealing type fittings have a 37° flare (sealing surface angle) and straight United National Fine Threads (UNF). The original design specification for the fittings comes from the Society of Automotive Engineers (SAE).

Standard: ISO 12151-5, ISO 8434-2, SAE J516

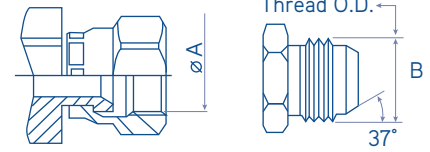

Tube O.D (inch)	Size	Thread UNF	ØA (mm)	ØB (mm)
1/4"	- 4	7/16" -20	10.00	11.10
5/16"	- 5	1/2" -20	11.60	12.70
3/8"	- 6	9/16" -18	13.00	14.30
1/2"	- 8	3/4" -16	17.60	19.10
5/8"	- 10	7/8" -14	20.50	22.20
3/4"	- 12	1.1/16" -12	24.60	27.00
7/8"	- 14	1.3/16" -12	28.30	30.10
1"	- 16	1.5/16" -12	31.30	33.30
1.1/4"	- 20	1.5/8" -12	39.20	41.30
1.1/2"	- 24	1.7/8" -12	45.60	47.60
2"	- 32	2.1/2" -12	61.50	63.50

O-Ring Face Seal (ORFS)

This fitting type have high level of sealing and good vibration resistance. The fittings use the O-ring compression mechanism to seal. The female fittings have flat faces and straight threaded UNF swivel nuts. The male fittings have the O-ring in a groove in the flat face.

Standard: ISO 12151-1, ISO 8434-3, SAE J516

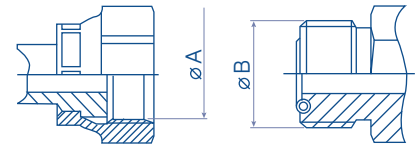

Tube O.D (inch)	Size	Thread UNF	ØA (mm)	ØB (mm)
1/4"	- 4	9/16" -18	13.00	14.20
3/8"	- 6	11/16" -16	15.90	17.50
1/2"	- 8	13/16" -16	19.10	20.60
5/8"	- 10	1" -14	23.80	25.40
3/4"	- 12	1.3/16" -12	28.20	30.10
1"	- 16	1.7/16" -12	34.15	36.50
1.1/4"	- 20	1.11/16" -12	40.50	42.90
1.1/2"	- 24	2" -12	48.80	50.80

Flange 3000 psi and 6000 psi

The sealing mechanism is through compression of the O-ring in the face of the flange head against the surface of the port connection. The flange fittings are generally separated into two pressure classes referred to as 21.0 MPa/ 3000 psi (SFL) or 42.0 MPa/ 6000 psi (SFS). In addition to these flanges, customer-specific Komatsu and CATERPILLAR flanges can also be found in the market. Standard: ISO 6162-1, ISO 6162-2

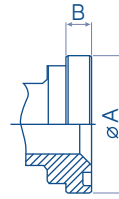

Flange (inch)	Size	3000 psi			6000 psi			SuperCat		
		ØA (mm)	B (mm)	O-ring (mm)	ØA (mm)	B (mm)	O-ring (mm)	ØA (mm)	B (mm)	O-ring (mm)
1/2"	- 8	30.18	6.73	18.64x3.53	31.75	7.75	18.64x3.53	31.75	14.22	18.64x3.53
5/8"*	- 10	34.20	6.73	21.70x3.53						
3/4"	- 12	38.10	6.73	24.99x3.53	41.28	8.76	24.99x3.53	41.28	14.22	24.99x3.53
1"	- 16	44.45	8.00	32.92x3.53	47.63	9.53	32.92x3.53	47.63	14.22	32.92x3.53
1.1/4"	- 20	50.80	8.00	37.69x3.53	53.98	10.29	37.69x3.53	53.98	14.22	37.69x3.53
1.1/2"	- 24	60.33	8.00	47.22x3.53	63.50	12.57	47.22x3.53	63.50	14.22	47.22x3.53
2"	- 32	71.42	9.53	56.74x3.53	79.38	12.57	56.74x3.53	79.38	14.22	56.74x3.53
2.1/2"	- 40	84.12	9.53	69.44x3.53						
3"	- 48	101.60	9.53	85.32x3.53						

* Although not in the SAE or the ISO standard the size -10 (5/8) flange head is gaining popularity. This flange is often found on Komatsu equipment or hydrostatic drives in agricultural machines.

Japanese Industrial Standard (JIS)

The Japanese Industrial Standard (JIS) uses a 30° sealing angle seat and either British Standard Pipe Parallel or metric threads.

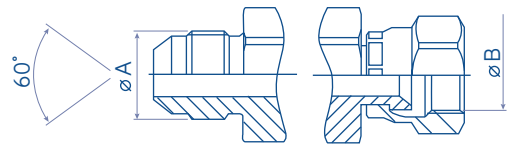

Thread metric	ØA (mm)	ØB (mm)	Thread BSP	ØA (mm)	ØB (mm)
M14X1.5	12.50	14.00	1/4" -19	11.50	13.20
M16X1.5	14.50	16.00	1/2" -14	18.60	20.90
M18X1.5	16.50	18.00	3/4" -14	24.10	26.40
M22X1.5	20.50	22.00	1" -11	30.30	33.20
M24X1.5	22.50	24.00			
M30X1.5	28.50	30.00			
M33X1.5	31.00	33.00			
M42X1.5	40.00	42.00			

BW23 – Multi Crimp Series One Piece Fitting

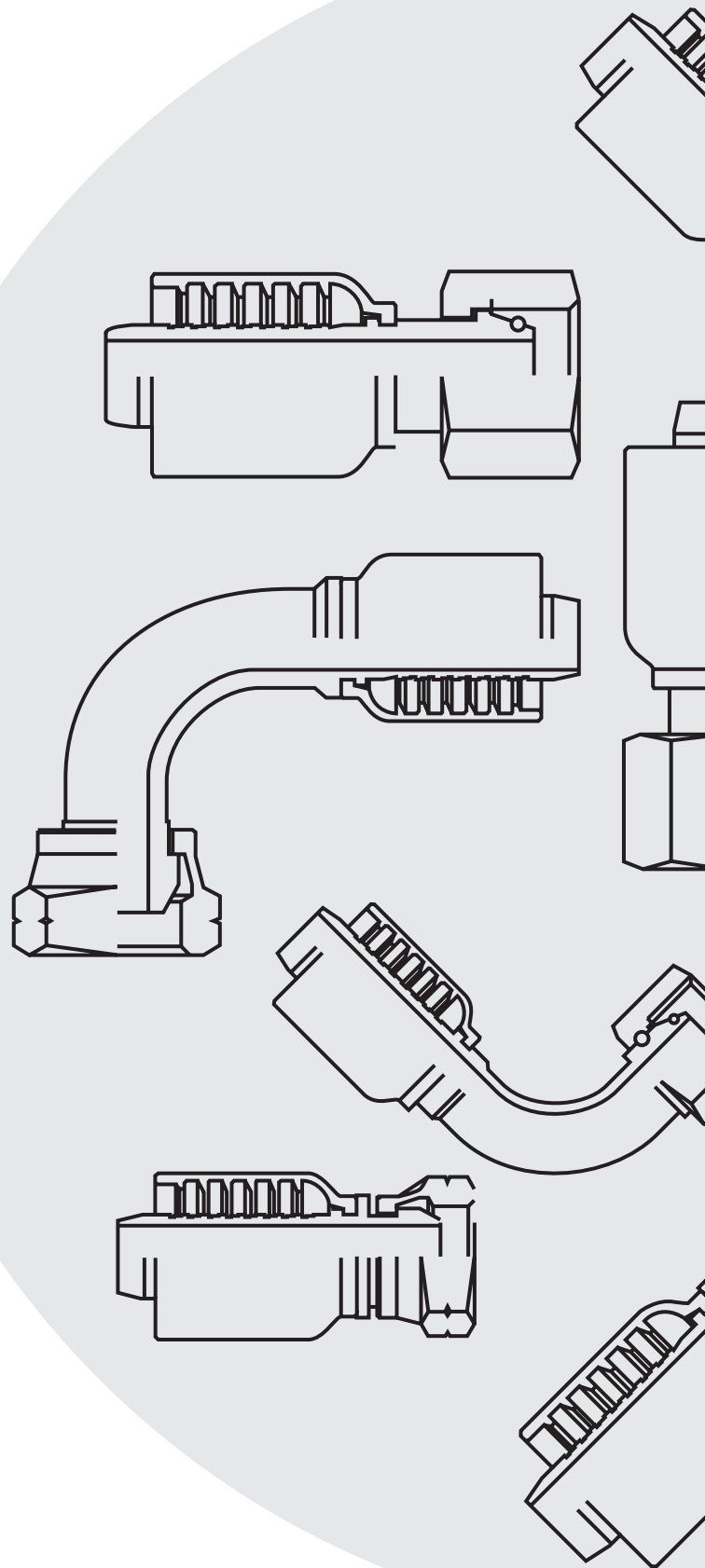

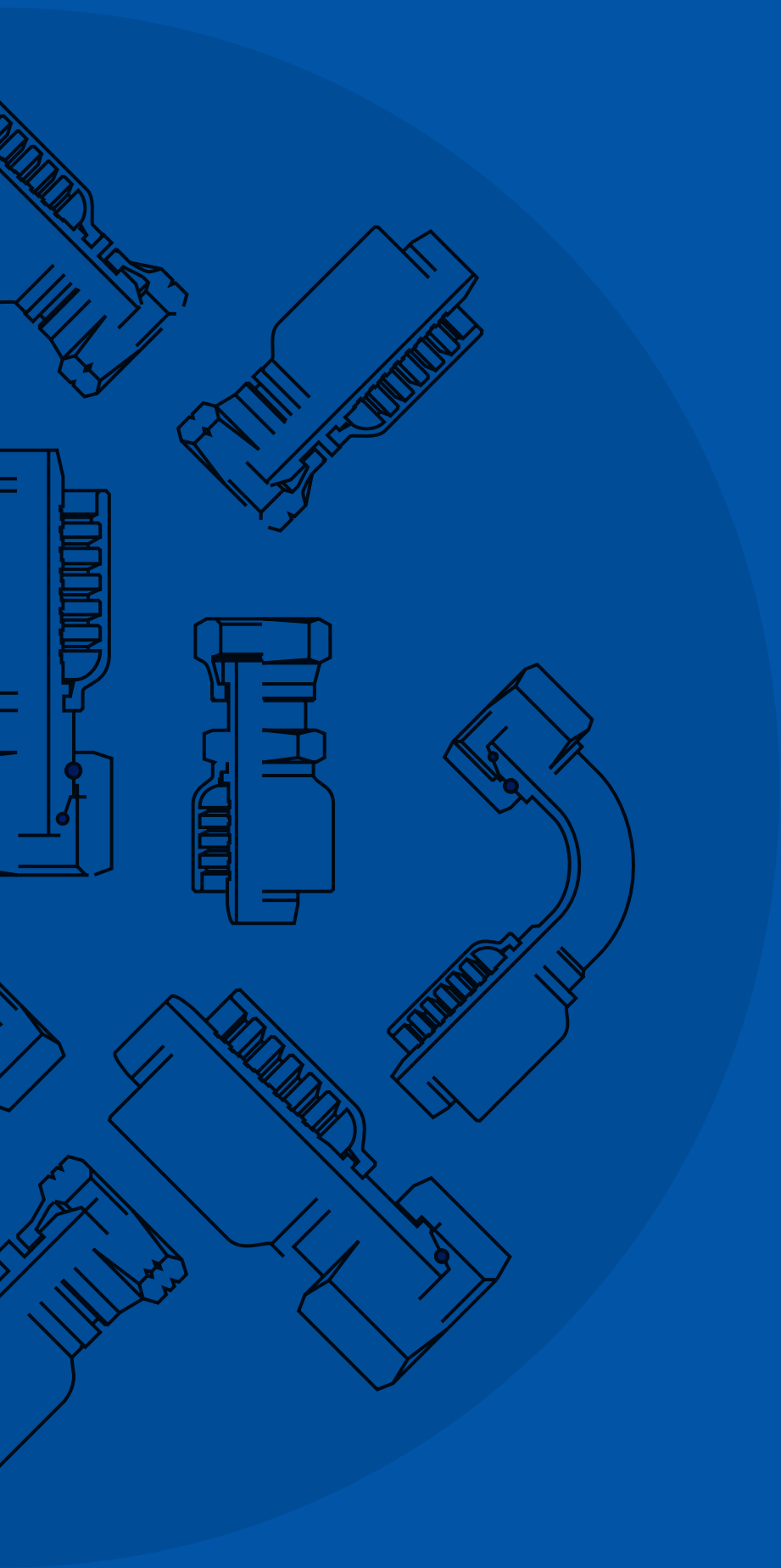

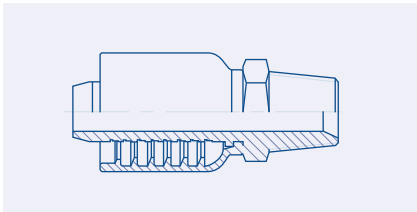

Male NPTF Pipe Rigid - MP
BW23.0400.

pag. 20

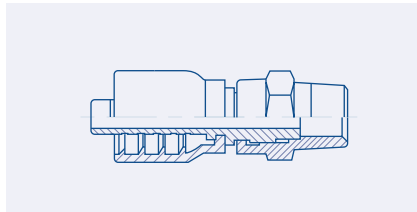

Male NPTF Swivel - MPX
BW23.0410.

pag. 21

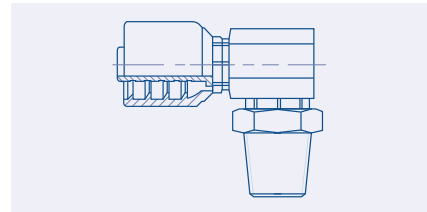

Male NPTF Swivel 90° Elbow - MPX90
BW23.0490.

pag. 22

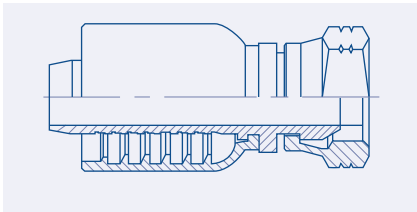

Female NPSM Pipe Swivel - FPX
BW23.3010.

pag. 23

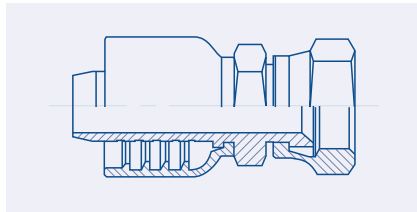

Female JIC 37° Swivel - FJ
BW23.4H12.

pag. 24

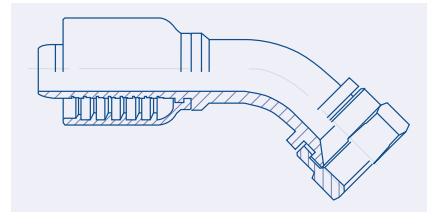

Female JIC 37° Swivel 45° Elbow - FJ45
BW23.4042.

pag. 25

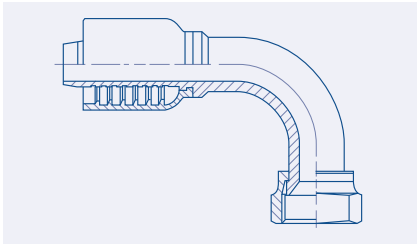

Female JIC 37° Swivel 90° Elbow - FJ90
BW23.4092.

pag. 26

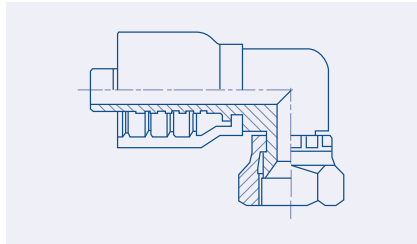

Female JIC 37° Swivel 90° Short Elbow - FJ90S
BW23.4082.

pag. 27

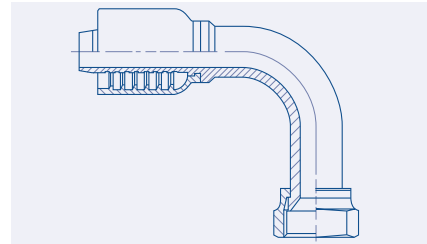

Female JIC 37° Swivel 90° Long Elbow - FJ90L
BW23.4092L.

pag. 28

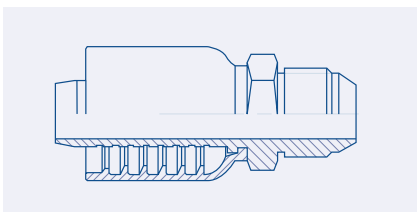

Male JIC 37° Rigid - MJ
BW23.2000.

pag. 29

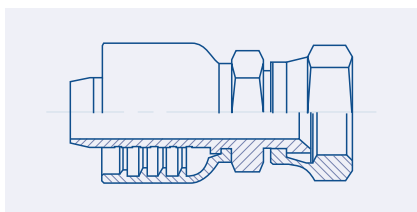

Female SAE 45° Swivel - FX
BW23.SH12.

pag. 30

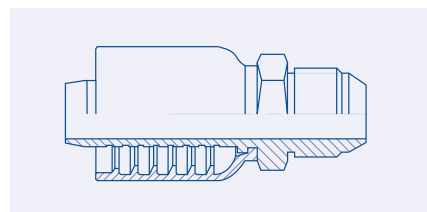

Male SAE 45° Rigid - MX
BW23.2S00.

pag. 30

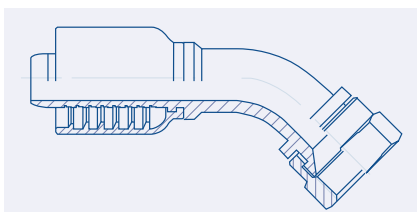

Female SAE 45° Swivel 45° Elbow - FX45
BW23.4S42.

pag. 31

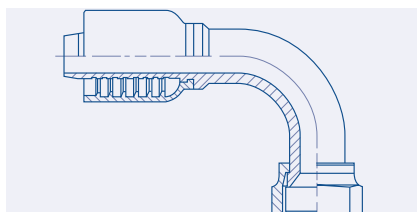

Female SAE 45° Swivel 90° Elbow - FX90
BW23.4S92.

pag. 31

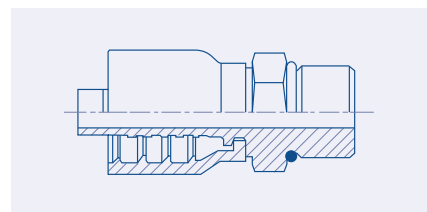

SAE Straight O-ring Boss Male - RA
BW23.2010.

pag. 32

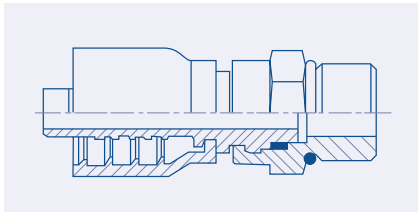

SAE Straight Swivel O-ring Boss Male - RAX

BW23.2012.

pag. 33

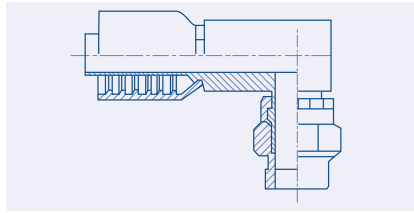

SAE 90° Elbow Swivel O-ring Boss Male - RAX90

BW23.2092.

pag. 34

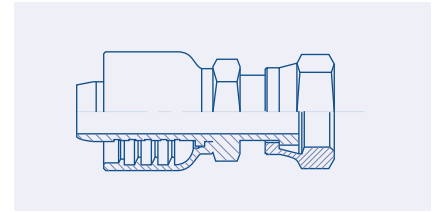

Female ORFS Swivel - OFT

BW23.44H4.

pag. 35

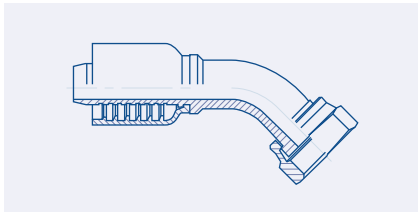

Female ORFS Swivel 45° Elbow - OFT45

BW23.4444.

pag. 36

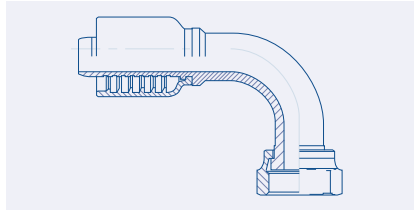

Female ORFS Swivel 90° Elbow - OFT90

BW23.4494.

pag. 37

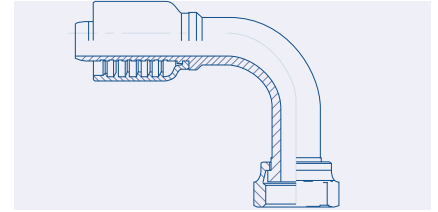

Female ORFS Swivel 90° Long Elbow - OFT90

BW23.4494L.

pag. 38

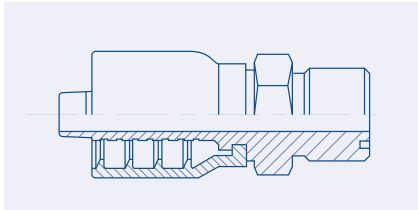

Male ORFS - OFTM

BW23.4000.

pag. 39

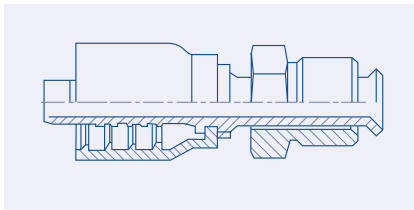

SAE Inverted 45° Flare Male - MSAE

BW23.2210.

pag. 40

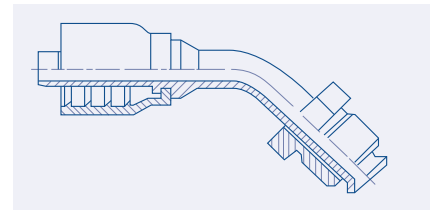

SAE Inverted 45° Flare 45° Elbow Male - MSAE 45

BW23.2240.

pag. 41

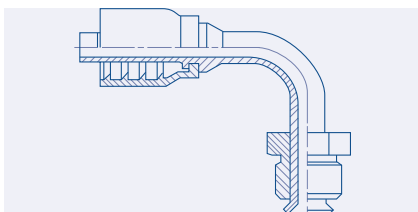

SAE Inverted 45° Flare 90° Elbow Male - MSAE 90

BW23.2290.

pag. 42

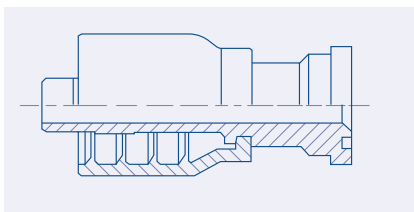

Straight SAE 3000 PSI Code 61 Flange - PA

BW23.7013.

pag. 43

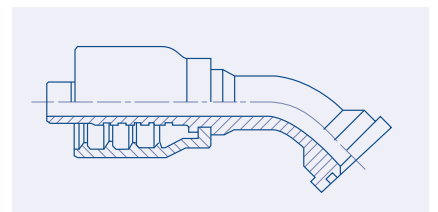

45° Elbow SAE 3000 PSI Code 61 Flange - PA45

BW23.7043.

pag. 44

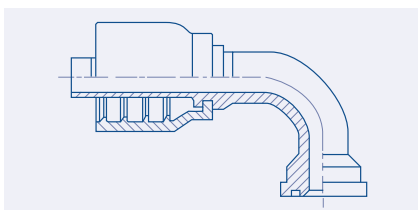

90° Elbow SAE 3000 PSI Code 61 Flange - PA90

BW23.7093.

pag. 45

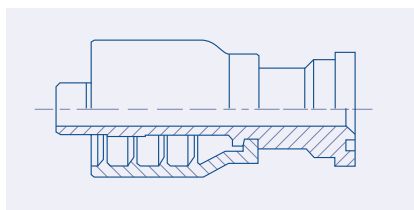

Straight SAE 6000 PSI Code 62 Flange - PH

BW23.7016.

pag. 46

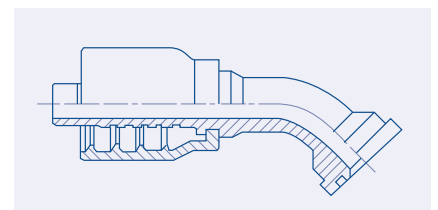

45° Elbow SAE 6000 PSI Code 62 Flange - PH45

BW23.7046.

pag. 47

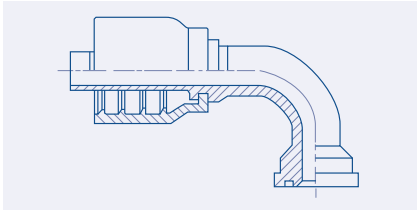

**90° Elbow SAE 6000 PSI
Code 62 Flange - PH90**

BW23.7096.

pag. 48

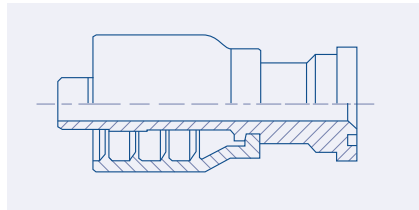

**Straight SuperCAT
Flange - SC**

BW23.7116.

pag. 49

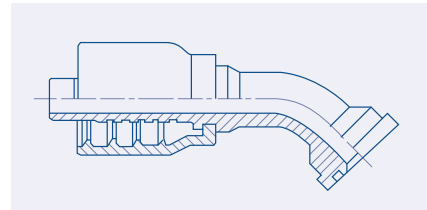

**45° Elbow SuperCAT
Flange - SC45**

BW23.7146.

pag. 50

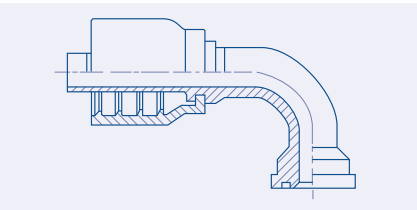

**90° Elbow SuperCAT
Flange - SC90**

BW23.7196.

pag. 51

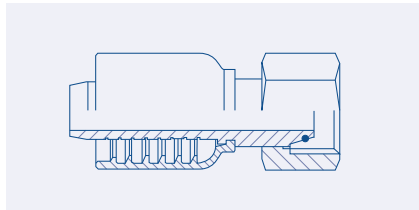

**Light 24° Metric Female
- DLF**

BW23.5013.

pag. 52

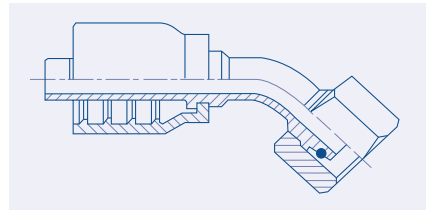

**Light 24° Metric 45° Elbow
Female - DLF45**

BW23.5043.

pag. 53

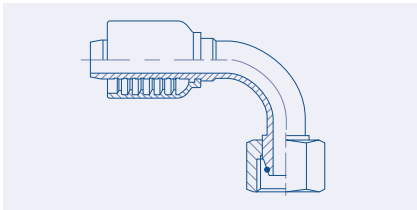

**Light 24° Metric 90° Elbow
Female - DLF90**

BW23.5093.

pag. 54

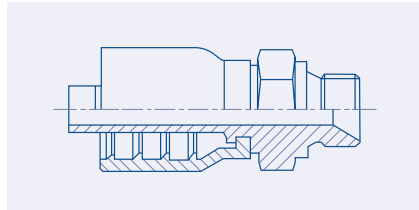

Light 24° Metric Male - DLM

BW23.1000.

pag. 55

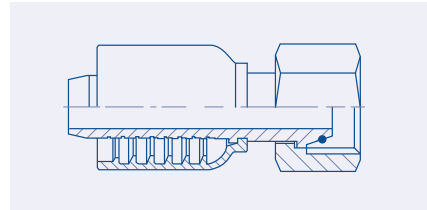

**Heavy 24° Metric Female
- DHF**

BW23.5113.

pag. 56

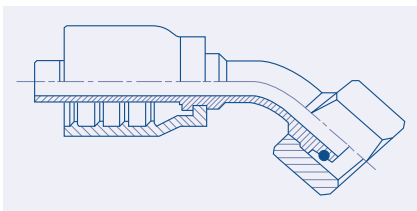

**Heavy 24° Metric 45° Elbow
Female - DHF45**

BW23.5143.

pag. 57

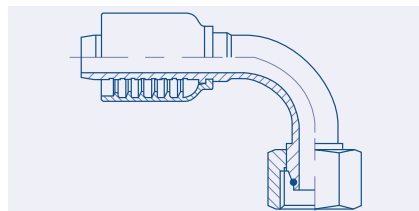

**Heavy 24° Metric 90° Elbow
Female - DHF90**

BW23.5193.

pag. 58

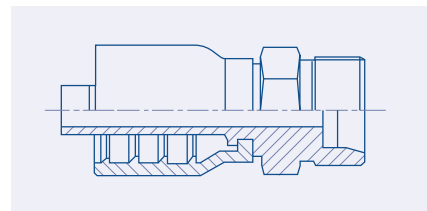

**Heavy 24° Metric Male -
DHM**

BW23.1100.

pag. 59

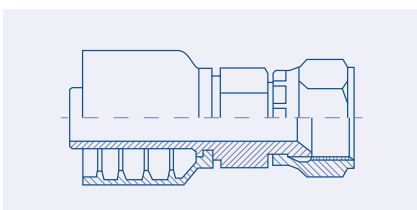

**JIS 30° Female Swivel
- FX-KOMA**

BW23.5911.

pag. 60

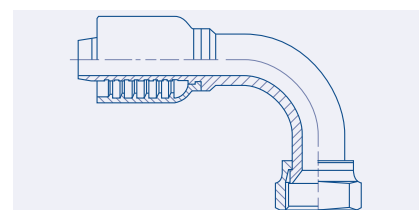

**Female JIS 30° Swivel 90°
Elbow - FX-KOMA90**

BW23.5991.

pag. 61

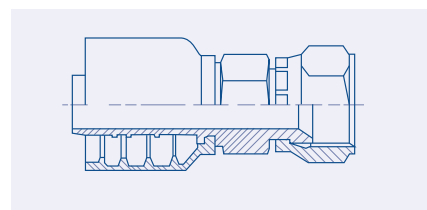

JIS 30° Female Swivel - JIS

BW23.3712.

pag. 62

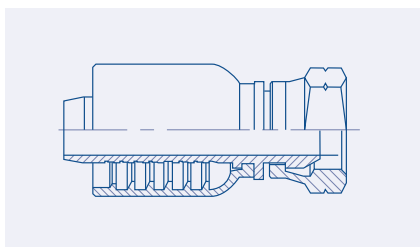

**BSP 60° Swivel Female
- BSPXF**

BW23.3012.

pag. 63

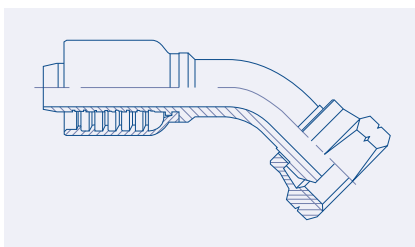

**BSP 60° Swivel 45° Elbow
Female - BSPXF45**

BW23.3042.

pag. 64

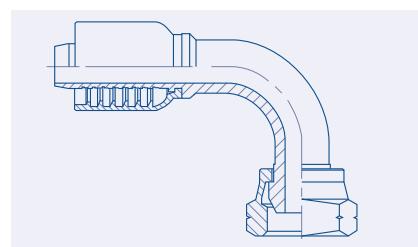

**BSP 60° Swivel 90° Elbow
Female - BSPXF90**

BW23.3092.

pag. 65

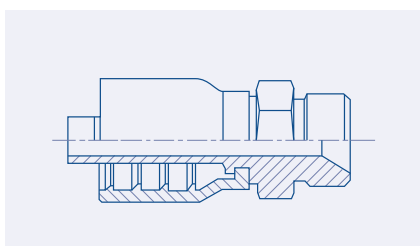

BSP 60° Male - BSPM

BW23.0100.

pag. 66

Male NPTF Pipe Rigid - MP

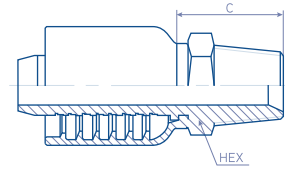

BW23.0400.

SAE J516 / SAE J514

REFERENCE	#	hose		thread	dimensions	
		dash	inch		C - Cut Off	HEX
BW2304-02MP	BW23.0400.0402	04	1/4"	1/8"-27	24,2	12
BW2304-04MP	BW23.0400.0404	04	1/4"	1/4"-18	29,7	14
BW2304-06MP	BW23.0400.0406	04	1/4"	3/8"-18	30,7	17
BW2304-08MP	BW23.0400.0408	04	1/4"	1/2"-14	35,7	22
BW2306-04MP	BW23.0400.0604	06	3/8"	1/4"-18	27,2	17
BW2306-06MP	BW23.0400.0606	06	3/8"	3/8"-18	28,7	19
BW2306-08MP	BW23.0400.0608	06	3/8"	1/2"-14	33,7	22
BW2308-04MP	BW23.0400.0804	08	1/2"	1/4"-18	31,0	19
BW2308-06MP	BW23.0400.0806	08	1/2"	3/8"-18	31,5	19
BW2308-08MP	BW23.0400.0808	08	1/2"	1/2"-14	35,5	22
BW2308-12MP	BW23.0400.0812	08	1/2"	3/4"-14	38,0	27
BW2310-08MP	BW23.0400.1008	10	5/8"	1/2"-14	37,5	22
BW2310-12MP	BW23.0400.1012	10	5/8"	3/4"-14	40,0	27
BW2312-08MP	BW23.0400.1208	12	3/4"	1/2"-14	38,8	27
BW2312-12MP	BW23.0400.1212	12	3/4"	3/4"-14	39,3	27
BW2312-16MP	BW23.0400.1216	12	3/4"	1"-11.5	45,8	36
BW2316-12MP	BW23.0400.1612	16	1"	3/4"-14	40,7	32
BW2316-16MP	BW23.0400.1616	16	1"	1"-11.5	46,2	36
BW2316-20MP	BW23.0400.1620	16	1"	1.1/4" - 11.5	49,2	46
BW2320-20MP	BW23.0400.2020	20	1.1/4"	1.1/4" - 11	49,5	46
BW2320-24MP	BW23.0400.2024	20	1.1/4"	1.1/2" - 11	52,5	50
BW2324-24MP	BW23.0400.2424	24	1.1/2"	1.1/2" - 11	52,4	50
BW2324-32MP	BW23.0400.2432	24	1.1/2"	2" - 11	58,4	65
BW2332-32MP	BW23.0400.3232	32	2"	2" - 11	57,9	65

MATERIAL: Carbon Steel

FINISH: Chromium-(VI) Free plating / ROHS compliant

Suitable to be used on medium and high pressure braided and spiral hoses:

FORZA UNO R1AT/1SN; FORZA UNO "SHARK SKIN" R1AT/1SN; FORZA UNO TROPIC R1AT/1SN; FORZA DUE R2AT/2SN; FORZA DUE "SHARK SKIN" R2AT/2SN; FORZA DUE TROPIC R2AT/2SN; BALPAC PREMIUM R16/2SC; BALPAC PREMIUM "SHARK SKIN" R16/2SC; BALPAC PREMIUM TROPIC R16/2SC; IMPACTUS 5K; IMPACTUS 6K; BALPAC 3000 R17/1SC; BALPAC 3000 "SHARK SKIN" R17/1SC; 2-MAX JACK; BALWASH 1W; BALWASH 2W; BALMASTER BESTFLEX R12; BALMASTER BESTFLEX 4SP; POWERSPIR BESTFLEX 4SH; POWERSPIR BESTFLEX R13 (3/4" & 1"); POWERSPIR BESTFLEX R15 (3/4" & 1")



Male NPTF Swivel - MPX

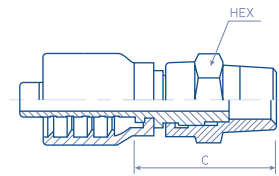

BW23.0410.
SAE J516 / SAE J514

REFERENCE	#	hose		thread	dimensions	
		dash	inch		C - Cut Off	HEX
BW2304-02MPX	BW23.0410.0402	04	1/4"	1/8"-27	37,3	17
BW2304-04MPX	BW23.0410.0404	04	1/4"	1/4"-18	37,5	17
BW2304-06MPX	BW23.0410.0406	04	1/4"	3/8"-18	35,7	19
BW2306-04MPX	BW23.0410.0604	06	3/8"	1/4"-18	35,5	17
BW2306-06MPX	BW23.0410.0606	06	3/8"	3/8"-18	35,2	19
BW2306-08MPX	BW23.0410.0608	06	3/8"	1/2"-14	42,0	22
BW2308-06MPX	BW23.0410.0806	08	1/2"	3/8"-18	36,0	19
BW2308-08MPX	BW23.0410.0808	08	1/2"	1/2"-14	42,2	22
BW2308-12MPX	BW23.0410.0812	08	1/2"	3/4"-14	41,2	32
BW2310-08MPX	BW23.0410.1008	12	3/4"	1/2"-14	42,2	22
BW2310-12MPX	BW23.0410.1012	10	5/8"	3/4"-14	42,0	32
BW2312-08MPX	BW23.0410.1208	12	3/4"	1/2"-14	42,2	22
BW2312-12MPX	BW23.0410.1212	12	3/4"	3/4"-14	41,2	32
BW2316-16MPX	BW23.0410.1616	16	1"	1"-11.5	47,5	38

MATERIAL: Carbon Steel

FINISH: Chromium-(VI) Free plating /
ROHS compliant

Suitable to be used on medium and high pressure braided and spiral hoses:

FORZA UNO R1AT/1SN; FORZA UNO "SHARK SKIN" R1AT/1SN; FORZA UNO TROPIC R1AT/1SN;
FORZA DUE R2AT/2SN; FORZA DUE "SHARK SKIN" R2AT/2SN; FORZA DUE TROPIC R2AT/2SN;
BALPAC PREMIUM R16/2SC; BALPAC PREMIUM "SHARK SKIN" R16/2SC; BALPAC PREMIUM
TROPIC R16/2SC; IMPACTUS 5K; IMPACTUS 6K; BALPAC 3000 R17/1SC; BALPAC 3000 "SHARK
SKIN" R17/1SC; 2-MAX JACK; BALWASH 1W; BALWASH 2W; BALMASTER BESTFLEX R12;
BALMASTER BESTFLEX 4SP; POWERSPIR BESTFLEX 4SH; POWERSPIR BESTFLEX R13 (3/4" &
1"); POWERSPIR BESTFLEX R15 (3/4" & 1")

Male NPTF Swivel 90° Elbow - MPX90

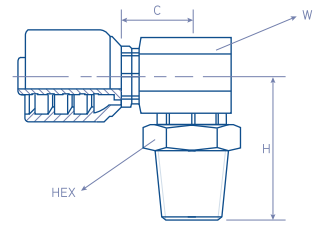

BW23.0490.

SAE J516 / SAE J514

REFERENCE	#	hose		thread	dimensions			
		dash	inch		C - Cut Off	H	W	HEX
BW2304-02MPX90	BW23.0490.0402	04	1/4"	1/8"-27	22,7	40,1	17	17
BW2304-04MPX90	BW23.0490.0404	04	1/4"	1/4"-18	22,7	40,1	17	17
BW2304-06MPX90	BW23.0490.0406	04	1/4"	3/8"-18	22,7	39,3	17	19
BW2306-04MPX90	BW23.0490.0604	06	3/8"	1/4"-18	21,0	40,9	17	17
BW2306-06MPX90	BW23.0490.0606	06	3/8"	3/8"-18	21,0	38,5	17	19
BW2306-08MPX90	BW23.0490.0608	06	3/8"	1/2"-14	23,5	40,1	24	22
BW2308-06MPX90	BW23.0490.0806	08	1/2"	3/8"-18	26,5	41,0	22	19
BW2308-08MPX90	BW23.0490.0808	08	1/2"	1/2"-14	26,5	47,0	22	22
BW2312-12MPX90	BW23.0490.1212	12	3/4"	3/4"-14	28,8	49,7	27	32
BW2316-16MPX90	BW23.0490.1616	16	1"	1"-11.5	42,7	60,0	32	38

MATERIAL: Carbon Steel

FINISH: Chromium-(VI) Free plating /
ROHS compliant

Suitable to be used on medium and high pressure braided and spiral hoses:

FORZA UNO R1AT/1SN; FORZA UNO "SHARK SKIN" R1AT/1SN; FORZA UNO TROPIC R1AT/1SN;
FORZA DUE R2AT/2SN; FORZA DUE "SHARK SKIN" R2AT/2SN; FORZA DUE TROPIC R2AT/2SN;
BALPAC PREMIUM R16/2SC; BALPAC PREMIUM "SHARK SKIN" R16/2SC; BALPAC PREMIUM
TROPIC R16/2SC; IMPACTUS 5K; IMPACTUS 6K; BALPAC 3000 R17/1SC; BALPAC 3000 "SHARK
SKIN" R17/1SC; 2-MAX JACK; BALWASH 1W; BALWASH 2W; BALMASTER BESTFLEX R12;
BALMASTER BESTFLEX 4SP; POWERSPIR BESTFLEX 4SH; POWERSPIR BESTFLEX R13 (3/4" &
1"); POWERSPIR BESTFLEX R15 (3/4" & 1")



Female NPSM Pipe Swivel - FPX

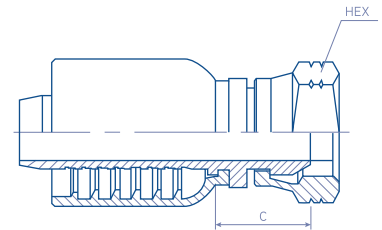

BW23.3010.

SAE J516 / SAE J514

REFERENCE	#	hose		thread	dimensions	
		dash	inch		C - Cut Off	HEX
BW2304-02FPX	BW23.3010.0402	04	1/4"	1/8"-27	23,7	14
BW2304-04FPX	BW23.3010.0404	04	1/4"	1/4"-18	26,7	19
BW2304-06FPX	BW23.3010.0406	04	1/4"	3/8"-18	29,1	22
BW2306-06FPX	BW23.3010.0606	06	3/8"	3/8"-18	27,2	22
BW2306-08FPX	BW23.3010.0608	06	3/8"	1/2"-14	29,0	27
BW2308-08FPX	BW23.3010.0808	08	1/2"	1/2"-14	30,7	27
BW2312-12FPX	BW23.3010.1212	12	3/4"	3/4"-14	35,3	32
BW2316-16FPX	BW23.3010.1616	16	1"	1"-11.5	38,0	41

MATERIAL: Carbon Steel

FINISH: Chromium-(VI) Free plating /
ROHS compliant

Suitable to be used on medium and high pressure braided and spiral hoses:

FORZA UNO R1AT/1SN; FORZA UNO "SHARK SKIN" R1AT/1SN; FORZA UNO TROPIC R1AT/1SN; FORZA DUE R2AT/2SN; FORZA DUE "SHARK SKIN" R2AT/2SN; FORZA DUE TROPIC R2AT/2SN; BALPAC PREMIUM R16/2SC; BALPAC PREMIUM "SHARK SKIN" R16/2SC; BALPAC PREMIUM TROPIC R16/2SC; IMPACTUS 5K; IMPACTUS 6K; BALPAC 3000 R17/1SC; BALPAC 3000 "SHARK SKIN" R17/1SC; 2-MAX JACK; BALWASH 1W; BALWASH 2W; BALMASTER BESTFLEX R12; BALMASTER BESTFLEX 4SP; POWERSPIR BESTFLEX 4SH; POWERSPIR BESTFLEX R13 (3/4" & 1"); POWERSPIR BESTFLEX R15 (3/4" & 1")

Female JIC 37° Swivel - FJ

BW23.4H12.

ISO 12151-5 / ISO 8434-2 / SAE J516 / SAE J514

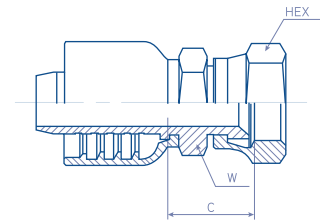

REFERENCE	#	hose		thread	dimensions		
		dash	inch		C - Cut Off	W	HEX
BW2304-04FJ	BW23.4H12.0404	04	1/4"	7/16"-20	22,7	14	14
BW2304-05FJ	BW23.4H12.0405	04	1/4"	1/2"-20	22,7	14	16
BW2304-06FJ	BW23.4H12.0406	04	3/8"	9/16"-18	24,7	14	19
BW2306-04FJ	BW23.4H12.0604	06	3/8"	7/16"-20	20,2	17	14
BW2306-06FJ	BW23.4H12.0606	06	3/8"	9/16"-18	20,7	17	19
BW2306-08FJ	BW23.4H12.0608	06	3/8"	3/4"-16	26,0	19	22
BW2306-10FJ	BW23.4H12.0610	06	3/8"	7/8"-14	28,5	22	27
BW2308-06FJ	BW23.4H12.0806	08	1/2"	9/16"-18	25,0	22	19
BW2308-08FJ	BW23.4H12.0808	08	1/2"	3/4"-16	27,0	22	22
BW2308-10FJ	BW23.4H12.0810	08	1/2"	7/8"-14	30,0	22	27
BW2308-12FJ	BW23.4H12.0812	08	1/2"	1.1/16"-12	34,0	25	32
BW2310-08FJ	BW23.4H12.1008	10	5/8"	3/4"-16	28,5	22	22
BW2310-10FJ	BW23.4H12.1010	10	5/8"	7/8"-14	30,5	22	27
BW2310-12FJ	BW23.4H12.1012	10	5/8"	1.1/16"-12	35,5	27	32
BW2312-10FJ	BW23.4H12.1210	12	3/4"	7/8"-14	33,3	27	27
BW2312-12FJ	BW23.4H12.1212	12	3/4"	1.1/16"-12	34,8	27	32
BW2312-14FJ	BW23.4H12.1214	12	3/4"	1.3/16"-12	36,3	32	38
BW2312-16FJ	BW23.4H12.1216	12	3/4"	1.5/16"-12	36,3	32	38
BW2316-12FJ	BW23.4H12.1612	16	1"	1.1/16"-12	34,2	32	32
BW2316-16FJ	BW23.4H12.1616	16	1"	1.5/16"-12	35,7	32	38
BW2316-20FJ	BW23.4H12.1620	16	1"	1.5/8"-12	40,7	42	50
BW2320-20FJ	BW23.4H12.2020	20	1.1/4"	1.5/8"-12	41,0	42	50
BW2320-24FJ	BW23.4H12.2024	20	1.1/4"	1.7/8"-12	44,0	50	57
BW2324-24FJ	BW23.4H12.2424	24	1.1/2"	1.7/8"-12	46,4	50	57
BW2324-32FJ	BW23.4H12.2432	24	1.1/2"	2.1/2"-12	50,4	64	75
BW2332-32FJ	BW23.4H12.3232	32	2"	2.1/2"-12	51,6	64	75

MATERIAL: Carbon Steel

FINISH: Chromium-(VI) Free plating /
ROHS compliant

Suitable to be used on medium and high pressure braided and spiral hoses:

FORZA UNO R1AT/1SN; FORZA UNO "SHARK SKIN" R1AT/1SN; FORZA UNO TROPIC R1AT/1SN; FORZA DUE R2AT/2SN; FORZA DUE "SHARK SKIN" R2AT/2SN; FORZA DUE TROPIC R2AT/2SN; BALPAC PREMIUM R16/2SC; BALPAC PREMIUM "SHARK SKIN" R16/2SC; BALPAC PREMIUM TROPIC R16/2SC; IMPACTUS 5K; IMPACTUS 6K; BALPAC 3000 R17/1SC; BALPAC 3000 "SHARK SKIN" R17/1SC; 2-MAX JACK; BALWASH 1W; BALWASH 2W; BALMASTER BESTFLEX R12; BALMASTER BESTFLEX 4SP; POWERSPIR BESTFLEX 4SH; POWERSPIR BESTFLEX R13 (3/4" & 1"); POWERSPIR BESTFLEX R15 (3/4" & 1")

Female JIC 37° Swivel 45° Elbow - FJ45

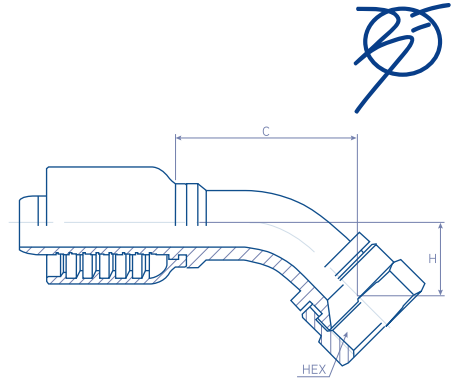

BW23.4042.

ISO 12151-5 / ISO 8434-2 / SAE J516 / SAE J514

REFERENCE	#	hose		thread	dimensions		
		dash	inch		C - Cut Off	H	HEX
BW2304-04FJ45	BW23.4042.0404	04	1/4"	7/16"-20	35,0	10,5	14
BW2304-05FJ45	BW23.4042.0405	04	1/4"	1/2"-20	35,0	10,5	16
BW2304-06FJ45	BW23.4042.0406	04	3/8"	9/16"-18	35,0	10,5	19
BW2306-06FJ45	BW23.4042.0606	06	3/8"	9/16"-18	38,5	14,5	19
BW2306-08FJ45	BW23.4042.0608	06	3/8"	3/4"-16	41,0	16,0	22
BW2306-10FJ45	BW23.4042.0610	06	3/8"	7/8"-14	40,0	16,5	27
BW2308-08FJ45	BW23.4042.0808	08	1/2"	3/4"-16	44,5	18,0	22
BW2308-10FJ45	BW23.4042.0810	08	1/2"	7/8"-14	46,5	21,3	27
BW2308-12FJ45	BW23.4042.0812	08	1/2"	1.1/16"-12	48,0	23,0	32
BW2310-10FJ45	BW23.4042.1010	10	5/8"	7/8"-14	52,0	21,3	27
BW2310-12FJ45	BW23.4042.1012	10	5/8"	1.1/16"-12	64,0	27,0	32
BW2312-12FJ45	BW23.4042.1212	12	3/4"	1.1/16"-12	70,0	27,0	32
BW2312-16FJ45	BW23.4042.1216	12	3/4"	1.5/16"-12	72,0	30,0	38
BW2316-16FJ45	BW23.4042.1616	16	1"	1.5/16"-12	77,0	32,0	38
BW2316-20FJ45	BW23.4042.1620	16	1"	1.5/8"-12	83,0	36,0	50
BW2320-20FJ45	BW23.4042.2020	20	1.1/4"	1.5/8"-12	101,0	37,0	50
BW2320-24FJ45	BW23.4042.2024	20	1.1/4"	1.7/8"-12	102,0	38,0	57
BW2324-24FJ45	BW23.4042.2424	24	1.1/2"	1.7/8"-12	123,0	44,0	57
BW2332-32FJ45	BW23.4042.3232	32	2"	2.1/2"-12	148,0	65,0	75

MATERIAL: Carbon Steel

FINISH: Chromium-(VI) Free plating /
ROHS compliant

Suitable to be used on medium and high pressure braided and spiral hoses:

FORZA UNO R1AT/1SN; FORZA UNO "SHARK SKIN" R1AT/1SN; FORZA UNO TROPIC R1AT/1SN;
FORZA DUE R2AT/2SN; FORZA DUE "SHARK SKIN" R2AT/2SN; FORZA DUE TROPIC R2AT/2SN;
BALPAC PREMIUM R16/2SC; BALPAC PREMIUM "SHARK SKIN" R16/2SC; BALPAC PREMIUM
TROPIC R16/2SC; IMPACTUS 5K; IMPACTUS 6K; BALPAC 3000 R17/1SC; BALPAC 3000 "SHARK
SKIN" R17/1SC; 2-MAX JACK; BALWASH 1W; BALWASH 2W; BALMASTER BESTFLEX R12;
BALMASTER BESTFLEX 4SP; POWERSPIR BESTFLEX 4SH; POWERSPIR BESTFLEX R13 (3/4" &
1"); POWERSPIR BESTFLEX R15 (3/4" & 1")

Female JIC 37° Swivel 90° Elbow - FJ90

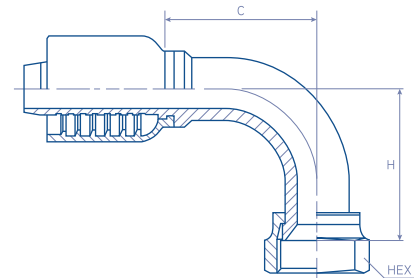

BW23.4092.

ISO 12151-5 / ISO 8434-2 / SAE J516 / SAE J514

REFERENCE	#	hose		thread	dimensions		
		dash	inch		C - Cut Off	H	HEX
BW2304-04FJ90	BW23.4092.0404	04	1/4"	7/16"-20	26,0	24,5	14
BW2304-05FJ90	BW23.4092.0405	04	1/4"	1/2"-20	29,0	25,0	16
BW2304-06FJ90	BW23.4092.0406	04	3/8"	9/16"-18	29,0	25,0	19
BW2306-06FJ90	BW23.4092.0606	06	3/8"	9/16"-18	34,0	31,5	19
BW2306-08FJ90	BW23.4092.0608	06	3/8"	3/4"-16	35,0	30,0	22
BW2306-10FJ90	BW23.4092.0610	06	3/8"	7/8"-14	37,1	38,0	27
BW2308-08FJ90	BW23.4092.0808	08	1/2"	3/4"-16	42,5	40,0	22
BW2308-10FJ90	BW23.4092.0810	08	1/2"	7/8"-14	37,0	40,5	27
BW2308-12FJ90	BW23.4092.0812	08	1/2"	1.1/16"-12	47,0	50,0	32
BW2310-10FJ90	BW23.4092.1010	10	5/8"	7/8"-14	50,0	47,5	27
BW2310-12FJ90	BW23.4092.1012	10	5/8"	1.1/16"-12	54,0	55,0	32
BW2312-12FJ90	BW23.4092.1212	12	3/4"	1.1/16"-12	55,5	55,0	32
BW2312-16FJ90	BW23.4092.1216	12	3/4"	1.5/16"-12	55,5	65,0	38
BW2316-16FJ90	BW23.4092.1616	16	1"	1.5/16"-12	72,0	71,0	38
BW2316-20FJ90	BW23.4092.1620	16	1"	1.5/8"-12	80,0	74,0	50
BW2320-20FJ90	BW23.4092.2020	20	1.1/4"	1.5/8"-12	86,5	78,0	50
BW2320-24FJ90	BW23.4092.2024	20	1.1/4"	1.7/8"-12	86,5	90,0	57
BW2324-24FJ90	BW23.4092.2424	24	1.1/2"	1.7/8"-12	114,0	100,0	57
BW2332-32FJ90	BW23.4092.3232	32	2"	2.1/2"-12	130,5	140,0	75

MATERIAL: Carbon Steel

FINISH: Chromium-(VI) Free plating /
ROHS compliant

Suitable to be used on medium and high pressure braided and spiral hoses:

FORZA UNO R1AT/1SN; FORZA UNO "SHARK SKIN" R1AT/1SN; FORZA UNO TROPIC R1AT/1SN;
FORZA DUE R2AT/2SN; FORZA DUE "SHARK SKIN" R2AT/2SN; FORZA DUE TROPIC R2AT/2SN;
BALPAC PREMIUM R16/2SC; BALPAC PREMIUM "SHARK SKIN" R16/2SC; BALPAC PREMIUM
TROPIC R16/2SC; IMPACTUS 5K; IMPACTUS 6K; BALPAC 3000 R17/1SC; BALPAC 3000 "SHARK
SKIN" R17/1SC; 2-MAX JACK; BALWASH 1W; BALWASH 2W; BALMASTER BESTFLEX R12;
BALMASTER BESTFLEX 4SP; POWERSPIR BESTFLEX 4SH; POWERSPIR BESTFLEX R13 (3/4" &
1"); POWERSPIR BESTFLEX R15 (3/4" & 1")



Female JIC 37° Swivel 90° Short Elbow - FJ90S

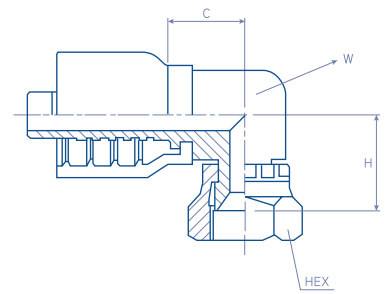

BW23.4082.

ISO 12151-5 / ISO 8434-2 / SAE J516 / SAE J514

REFERENCE	#	hose		thread	dimensions			
		dash	inch		C - Cut Off	H	W	HEX
BW2304-04FJ90S	BW23.4082.0404	04	1/4"	7/16"-20	18,5	19,6	11	14
BW2304-05FJ90S	BW23.4082.0405	04	1/4"	1/2"-20	18,5	21,5	14	16
BW2304-06FJ90S	BW23.4082.0406	04	3/8"	9/16"-18	18,5	21,8	14	19
BW2306-06FJ90S	BW23.4082.0606	06	3/8"	9/16"-18	21,5	25,5	16	19
BW2306-08FJ90S	BW23.4082.0608	06	3/8"	3/4"-16	21,5	26,5	19	22
BW2308-08FJ90S	BW23.4082.0808	08	1/2"	3/4"-16	25,5	29,5	19	22
BW2308-10FJ90S	BW23.4082.0810	08	1/2"	7/8"-14	25,5	28,0	22	27
BW2310-10FJ90S	BW23.4082.1010	10	5/8"	7/8"-14	25,5	28,0	22	27
BW2312-12FJ90S	BW23.4082.1212	12	3/4"	1.1/16"-12	30,8	28,5	30,7	28,5
BW2312-16FJ90S	BW23.4082.1216	12	3/4"	1.5/16"-12	30,0	33,5	33	38
BW2316-16FJ90S	BW23.4082.1616	16	1"	1.5/16"-12	33,5	30,5	33,5	30,5

MATERIAL: Carbon Steel

FINISH: Chromium-(VI) Free plating /
ROHS compliant

Suitable to be used on medium and high pressure braided and spiral hoses:

FORZA UNO R1AT/1SN; FORZA UNO "SHARK SKIN" R1AT/1SN; FORZA UNO TROPIC R1AT/1SN;
FORZA DUE R2AT/2SN; FORZA DUE "SHARK SKIN" R2AT/2SN; FORZA DUE TROPIC R2AT/2SN;
BALPAC PREMIUM R16/2SC; BALPAC PREMIUM "SHARK SKIN" R16/2SC; BALPAC PREMIUM
TROPIC R16/2SC; IMPACTUS 5K; IMPACTUS 6K; BALPAC 3000 R17/1SC; BALPAC 3000 "SHARK
SKIN" R17/1SC; 2-MAX JACK; BALWASH 1W; BALWASH 2W; BALMASTER BESTFLEX R12;
BALMASTER BESTFLEX 4SP; POWERSPIR BESTFLEX 4SH; POWERSPIR BESTFLEX R13 (3/4" &
1"); POWERSPIR BESTFLEX R15 (3/4" & 1")

Female JIC 37° Swivel 90° Long Elbow - FJ90L

BW23.4092L.

ISO 12151-5 / ISO 8434-2 / SAE J516 / SAE J514

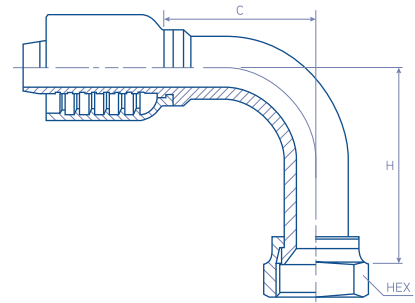

REFERENCE	#	hose		thread	dimensions		
		dash	inch		C - Cut Off	W	HEX
BW2304-04FJ90L	BW23.4092.0404L	04	1/4"	7/16"-20	31,9	46,0	14
BW2304-05FJ90L	BW23.4092.0405L	04	1/4"	1/2"-20	32,0	46,0	16
BW2304-06FJ90L	BW23.4092.0406L	04	3/8"	9/16"-18	31,7	46,0	19
BW2306-06FJ90L	BW23.4092.0606L	06	3/8"	9/16"-18	33,0	54,0	19
BW2306-08FJ90L	BW23.4092.0608L	06	3/8"	3/4"-16	38,0	64,0	22
BW2308-08FJ90L	BW23.4092.0808L	08	1/2"	3/4"-16	44,0	64,0	22
BW2308-10FJ90L	BW23.4092.0810L	08	1/2"	7/8"-14	46,0	65,0	27
BW2310-10FJ90L	BW23.4092.1010L	10	5/8"	7/8"-14	55,0	70,0	27
BW2312-12FJ90L	BW23.4092.1212L	12	3/4"	1.1/16"-12	56,0	96,0	32
BW2312-16FJ90L	BW23.4092.1216L	12	3/4"	1.5/16"-12	60,0	100,0	38
BW2316-16FJ90L	BW23.4092.1616L	16	1"	1.5/16"-12	76,0	114,0	38

MATERIAL: Carbon Steel

FINISH: Chromium-(VI) Free plating /
ROHS compliant

Suitable to be used on medium and high pressure braided and spiral hoses:

FORZA UNO R1AT/1SN; FORZA UNO "SHARK SKIN" R1AT/1SN; FORZA UNO TROPIC R1AT/1SN;
FORZA DUE R2AT/2SN; FORZA DUE "SHARK SKIN" R2AT/2SN; FORZA DUE TROPIC R2AT/2SN;
BALPAC PREMIUM R16/2SC; BALPAC PREMIUM "SHARK SKIN" R16/2SC; BALPAC PREMIUM
TROPIC R16/2SC; IMPACTUS 5K; IMPACTUS 6K; BALPAC 3000 R17/1SC; BALPAC 3000 "SHARK
SKIN" R17/1SC; 2-MAX JACK; BALWASH 1W; BALWASH 2W; BALMASTER BESTFLEX R12;
BALMASTER BESTFLEX 4SP; POWERSPIR BESTFLEX 4SH; POWERSPIR BESTFLEX R13 (3/4" &
1"); POWERSPIR BESTFLEX R15 (3/4" & 1")



Male JIC 37° Rigid - MJ

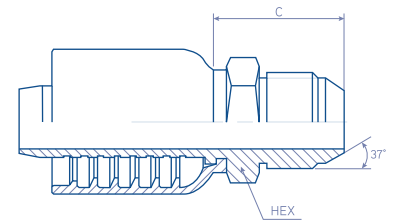

BW23.2000.

ISO 12151-5 / ISO 8434-2 / SAE J516 / SAE J514

REFERENCE	#	hose		thread	dimensions	
		dash	inch		C - Cut Off	HEX
BW2304-04MJ	BW23.2000.0404	04	1/4"	7/16"-20	27,7	14
BW2304-05MJ	BW23.2000.0405	04	1/4"	1/2"-20	28,2	14
BW2304-06MJ	BW23.2000.0406	04	1/4"	9/16"-18	28,2	17
BW2306-06MJ	BW23.2000.0606	06	3/8"	9/16"-18	27,0	17
BW2306-08MJ	BW23.2000.0608	06	3/8"	3/4"-16	31,2	19
BW2306-10MJ	BW23.2000.0610	06	3/8"	7/8"-14	48,0	24
BW2308-06MJ	BW23.2000.0806	08	1/2"	9/16"-18	29,6	19
BW2308-08MJ	BW23.2000.0808	08	1/2"	3/4"-16	32,2	22
BW2308-10MJ	BW23.2000.0810	08	1/2"	7/8"-14	37,3	24
BW2308-12MJ	BW23.2000.0812	08	1/2"	1.1/16"-12	41,4	27
BW2310-08MJ	BW23.2000.1008	10	5/8"	3/4"-16	38,0	24
BW2310-10MJ	BW23.2000.1010	10	5/8"	7/8"-14	39,3	24
BW2310-12MJ	BW23.2000.1012	10	5/8"	1.1/16"-12	42,0	27
BW2312-10MJ	BW23.2000.1210	12	3/4"	7/8"-14	40,0	27
BW2312-12MJ	BW23.2000.1212	12	3/4"	1.1/16"-12	41,7	27
BW2312-14MJ	BW23.2000.1214	12	3/4"	1.3/16"-12	46,5	32
BW2312-16MJ	BW23.2000.1216	12	3/4"	1.5/16"-12	47,1	36
BW2316-16MJ	BW23.2000.1616	16	1"	1.5/16"-12	44,5	36
BW2316-20MJ	BW23.2000.1620	16	1"	1.5/8"-12	46,0	46
BW2320-20MJ	BW23.2000.2020	20	1.1/4"	1.5/8"-12	48,0	46
BW2324-24MJ	BW23.2000.2424	24	1.1/2"	1.7/8"-12	58,9	50
BW2332-32MJ	BW23.2000.3232	32	2"	2.1/2"-12	70,5	65

MATERIAL: Carbon Steel

FINISH: Chromium-(VI) Free plating /
ROHS compliant

Suitable to be used on medium and high pressure braided and spiral hoses:

FORZA UNO R1AT/1SN; FORZA UNO "SHARK SKIN" R1AT/1SN; FORZA UNO TROPIC R1AT/1SN;
FORZA DUE R2AT/2SN; FORZA DUE "SHARK SKIN" R2AT/2SN; FORZA DUE TROPIC R2AT/2SN;
BALPAC PREMIUM R16/2SC; BALPAC PREMIUM "SHARK SKIN" R16/2SC; BALPAC PREMIUM
TROPIC R16/2SC; IMPACTUS 5K; IMPACTUS 6K; BALPAC 3000 R17/1SC; BALPAC 3000 "SHARK
SKIN" R17/1SC; 2-MAX JACK; BALWASH 1W; BALWASH 2W; BALMASTER BESTFLEX R12;
BALMASTER BESTFLEX 4SP; POWERSPIR BESTFLEX 4SH; POWERSPIR BESTFLEX R13 (3/4" &
1"); POWERSPIR BESTFLEX R15 (3/4" & 1")

Female SAE 45° Swivel - FX

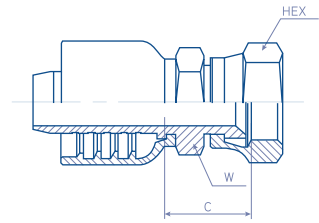

BW23.SH12.

SAE J512 / SAE J513

REFERENCE	#	hose dash	hose Ø inch	thread	C cut off mm	W mm	HEX mm
BW2306-06FX	BW23.SH12.0606	-6	3/8"	5/8" - 18 UNF	26.3	19	22
BW2312-12FX	BW23.SH12.1212	-12	3/4"	1.1/16" - 14 UNS	33.7	27	32

MATERIAL: Carbon Steel

FINISH: Chromium-(VI) Free plating /
ROHS compliant

VERSIONS: Stainless Steel (add an 'S'
at the end of the REFERENCE)

Suitable to be used on medium and high pressure braided and spiral hoses:

FORZA UNO R1AT/1SN; FORZA UNO "SHARK SKIN" R1AT/1SN; FORZA UNO TROPIC R1AT/1SN; FORZA DUE R2AT/2SN; FORZA DUE "SHARK SKIN" R2AT/2SN; FORZA DUE TROPIC R2AT/2SN; BALPAC PREMIUM R16/2SC; BALPAC PREMIUM "SHARK SKIN" R16/2SC; BALPAC PREMIUM TROPIC R16/2SC; IMPACTUS 5K; IMPACTUS 6K; BALPAC 3000 R17/1SC; BALPAC 3000 "SHARK SKIN" R17/1SC; 2-MAX JACK; BALWASH 1W; BALWASH 2W; BALMASTER BESTFLEX R12; BALMASTER BESTFLEX 4SP; POWERSPIR BESTFLEX 4SH; POWERSPIR BESTFLEX R13 (3/4"); POWERSPIR BESTFLEX R15 (3/4")

Male SAE 45° Rigid - MX

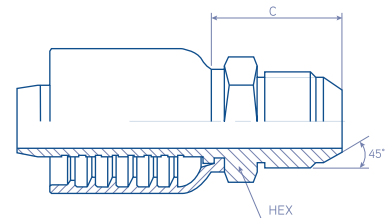

BW23.2S00.

SAE J512 / SAE J513

REFERENCE	#	hose dash	hose Ø inch	thread	C cut off mm	HEX mm
BW2306-06MX	BW23.2S00.0606	-6	3/8"	5/8" - 18 UNF	27.1	22
BW2312-12MX	BW23.2S00.1212	-12	3/4"	1.1/16" - 14 UNS	40.6	32

MATERIAL: Carbon Steel

FINISH: Chromium-(VI) Free plating /
ROHS compliant

VERSIONS: Stainless Steel (add an 'S'
at the end of the REFERENCE)

Suitable to be used on medium and high pressure braided and spiral hoses:

FORZA UNO R1AT/1SN; FORZA UNO "SHARK SKIN" R1AT/1SN; FORZA UNO TROPIC R1AT/1SN; FORZA DUE R2AT/2SN; FORZA DUE "SHARK SKIN" R2AT/2SN; FORZA DUE TROPIC R2AT/2SN; BALPAC PREMIUM R16/2SC; BALPAC PREMIUM "SHARK SKIN" R16/2SC; BALPAC PREMIUM TROPIC R16/2SC; IMPACTUS 5K; IMPACTUS 6K; BALPAC 3000 R17/1SC; BALPAC 3000 "SHARK SKIN" R17/1SC; 2-MAX JACK; BALWASH 1W; BALWASH 2W; BALMASTER BESTFLEX R12; BALMASTER BESTFLEX 4SP; POWERSPIR BESTFLEX 4SH; POWERSPIR BESTFLEX R13 (3/4"); POWERSPIR BESTFLEX R15 (3/4")



Female SAE 45° Swivel 45° Elbow - FX45

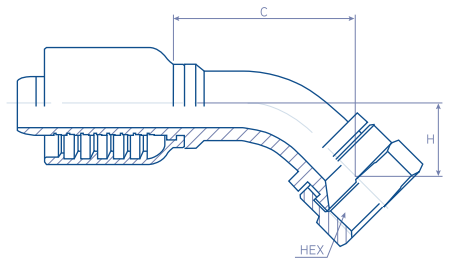

BW23.4S42.
SAE J512 / SAE J513

REFERENCE	#	hose dash	hose Ø inch	thread	C cut off mm	H mm	HEX mm
BW2306-06FX45	BW23.4S42.0606	-6	3/8"	5/8" - 18 UNF	34.0	15.5	22
BW2312-12FX45	BW23.4S42.1212	-12	3/4"	1.1/16" - 14 UNS	55.5	27.0	32

MATERIAL: Carbon Steel

FINISH: Chromium-(VI) Free plating / ROHS compliant

VERSIONS: Stainless Steel (add an 'S' at the end of the REFERENCE)

Suitable to be used on medium and high pressure braided and spiral hoses:

FORZA UNO R1AT/1SN; FORZA UNO "SHARK SKIN" R1AT/1SN; FORZA UNO TROPIC R1AT/1SN; FORZA DUE R2AT/2SN; FORZA DUE "SHARK SKIN" R2AT/2SN; FORZA DUE TROPIC R2AT/2SN; BALPAC PREMIUM R16/2SC; BALPAC PREMIUM "SHARK SKIN" R16/2SC; BALPAC PREMIUM TROPIC R16/2SC; IMPACTUS 5K; IMPACTUS 6K; BALPAC 3000 R17/1SC; BALPAC 3000 "SHARK SKIN" R17/1SC; 2-MAX JACK; BALWASH 1W; BALWASH 2W; BALMASTER BESTFLEX R12; BALMASTER BESTFLEX 4SP; POWERSPIR BESTFLEX 4SH; POWERSPIR BESTFLEX R13 (3/4"); POWERSPIR BESTFLEX R15 (3/4")

Female SAE 45° Swivel 90° Elbow - FX90

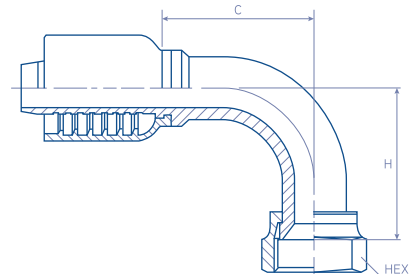

BW23.4S92.
SAE J512 / SAE J513

REFERENCE	#	hose dash	hose Ø inch	thread	C cut off mm	H mm	HEX mm
BW2306-06FX90	BW23.4S92.0606	-6	3/8"	5/8" - 18 UNF	34.0	30	22
BW2312-12FX90	BW23.4S92.1212	-12	3/4"	1.1/16" - 14 UNS	55.5	55	32

MATERIAL: Carbon Steel

FINISH: Chromium-(VI) Free plating / ROHS compliant

VERSIONS: Stainless Steel (add an 'S' at the end of the REFERENCE)

Suitable to be used on medium and high pressure braided and spiral hoses:

FORZA UNO R1AT/1SN; FORZA UNO "SHARK SKIN" R1AT/1SN; FORZA UNO TROPIC R1AT/1SN; FORZA DUE R2AT/2SN; FORZA DUE "SHARK SKIN" R2AT/2SN; FORZA DUE TROPIC R2AT/2SN; BALPAC PREMIUM R16/2SC; BALPAC PREMIUM "SHARK SKIN" R16/2SC; BALPAC PREMIUM TROPIC R16/2SC; IMPACTUS 5K; IMPACTUS 6K; BALPAC 3000 R17/1SC; BALPAC 3000 "SHARK SKIN" R17/1SC; 2-MAX JACK; BALWASH 1W; BALWASH 2W; BALMASTER BESTFLEX R12; BALMASTER BESTFLEX 4SP; POWERSPIR BESTFLEX 4SH; POWERSPIR BESTFLEX R13 (3/4"); POWERSPIR BESTFLEX R15 (3/4")

SAE Straight O-ring Boss Male - RA

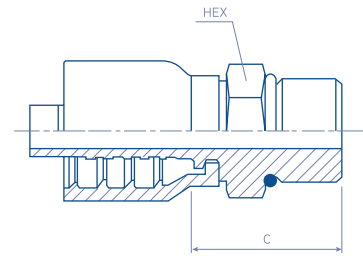

BW23.2010.

ISO 12151-5 / ISO 8434-2 / SAE J512 / SAE J513

REFERENCE	#	hose		thread	dimensions	
		dash	inch		C - Cut Off	HEX
BW2304-04RA	BW23.2010.0404	04	1/4"	7/16"-20	23,4	14
BW2306-06RA	BW23.2010.0606	06	3/8"	9/16"-18	23	17
BW2306-08RA	BW23.2010.0608	06	3/8"	3/4"-16	26,2	22
BW2308-08RA	BW23.2010.0808	08	1/2"	3/4"-16	27,9	22
BW2308-10RA	BW23.2010.0810	08	1/2"	7/8"-14	31,9	27
BW2308-12RA	BW23.2010.0812	08	1/2"	1.1/16"-12	36	32
BW2310-10RA	BW23.2010.1010	10	5/8"	7/8"-14	33,2	27
BW2310-12RA	BW23.2010.1012	10	5/8"	1.1/16"-12	37,4	32
BW2312-12RA	BW23.2010.1212	12	3/4"	1.1/16"-12	36,5	32
BW2312-16RA	BW23.2010.1216	12	3/4"	1.5/16"-12	39	41
BW2316-16RA	BW23.2010.1616	16	1"	1.5/16"-12	35,7	38

MATERIAL: Carbon Steel

FINISH: Chromium-(VI) Free plating / ROHS compliant

Suitable to be used on medium and high pressure braided and spiral hoses:

FORZA UNO R1AT/1SN; FORZA UNO "SHARK SKIN" R1AT/1SN; FORZA UNO TROPIC R1AT/1SN; FORZA DUE R2AT/2SN; FORZA DUE "SHARK SKIN" R2AT/2SN; FORZA DUE TROPIC R2AT/2SN; BALPAC PREMIUM R16/2SC; BALPAC PREMIUM "SHARK SKIN" R16/2SC; BALPAC PREMIUM TROPIC R16/2SC; IMPACTUS 5K; IMPACTUS 6K; BALPAC 3000 R17/1SC; BALPAC 3000 "SHARK SKIN" R17/1SC; 2-MAX JACK; BALWASH 1W; BALWASH 2W; BALMASTER BESTFLEX R12; BALMASTER BESTFLEX 4SP; POWERSPIR BESTFLEX 4SH; POWERSPIR BESTFLEX R13 (3/4" & 1"); POWERSPIR BESTFLEX R15 (3/4" & 1")



SAE Straight Swivel O-ring Boss Male - RAX

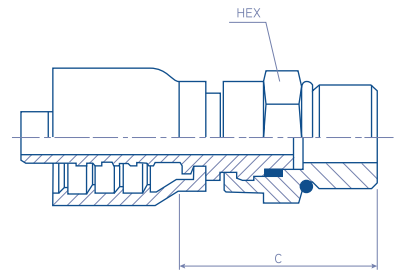

BW23.2012.

ISO 12151-5 / ISO 8434-2 / SAE J512 / SAE J513

REFERENCE	#	hose		thread	dimensions	
		dash	inch		C - Cut Off	HEX
BW2304-04RAX	BW23.2012.0404	04	1/4"	7/16"-20	39,7	19
BW2304-06RAX	BW23.2012.0406	04	1/4"	9/16"-18	40,2	19
BW2306-06RAX	BW23.2012.0606	06	3/8"	9/16"-18	38,2	19
BW2306-08RAX	BW23.2012.0608	06	3/8"	3/4"-16	42,7	22
BW2308-08RAX	BW23.2012.0808	08	1/2"	3/4"-16	44,5	22
BW2308-10RAX	BW23.2012.0810	08	1/2"	7/8"-14	38,0	27
BW2308-12RAX	BW23.2012.0812	08	1/2"	1.1/16"-12	47,3	32
BW2310-10RAX	BW23.2012.1010	10	5/8"	7/8"-14	39,5	27
BW2312-12RAX	BW23.2012.1212	12	3/4"	1.1/16"-12	48,1	32
BW2312-16RAX	BW23.2012.1216	12	3/4"	1.5/16"-12	53,1	41
BW2316-16RAX	BW23.2012.1616	16	1"	1.5/16"-12	53,0	41

MATERIAL: Carbon Steel

FINISH: Chromium-(VI) Free plating / ROHS compliant

Suitable to be used on medium and high pressure braided and spiral hoses:

FORZA UNO R1AT/1SN; FORZA UNO "SHARK SKIN" R1AT/1SN; FORZA UNO TROPIC R1AT/1SN; FORZA DUE R2AT/2SN; FORZA DUE "SHARK SKIN" R2AT/2SN; FORZA DUE TROPIC R2AT/2SN; BALPAC PREMIUM R16/2SC; BALPAC PREMIUM "SHARK SKIN" R16/2SC; BALPAC PREMIUM TROPIC R16/2SC; IMPACTUS 5K; IMPACTUS 6K; BALPAC 3000 R17/1SC; BALPAC 3000 "SHARK SKIN" R17/1SC; 2-MAX JACK; BALWASH 1W; BALWASH 2W; BALMASTER BESTFLEX R12; BALMASTER BESTFLEX 4SP; POWERSPIR BESTFLEX 4SH; POWERSPIR BESTFLEX R13 (3/4" & 1"); POWERSPIR BESTFLEX R15 (3/4" & 1")

SAE 90° Elbow Swivel O-ring Boss Male - RAX90

BW23.2092.

ISO 12151-5 / ISO 8434-2 / SAE J512 / SAE J513

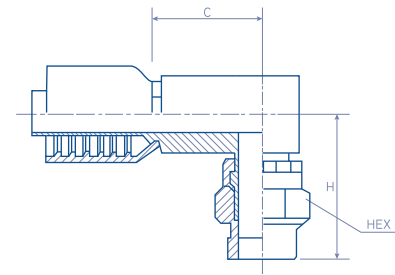

REFERENCE	#	hose		thread	dimensions		
		dash	inch		C - Cut Off	H	HEX
BW2306-06RA90X	BW23.2092.0606	06	3/8"	9/16"-18	38,0	50,0	43,3
BW2306-08RA90X	BW23.2092.0608	06	3/8"	3/4"-16	40,0	47,0	45,0
BW2308-08RA90X	BW23.2092.0808	08	1/2"	3/4"-16	43,0	47,0	45,0
BW2308-10RA90X	BW23.2092.0810	08	1/2"	7/8"-14	43,0	49,0	39,5
BW2312-12RA90X	BW23.2092.1212	12	3/4"	1.1/16"-12	48,0	58,0	51,7

MATERIAL: Carbon Steel

FINISH: Chromium-(VI) Free plating /
ROHS compliant

Suitable to be used on medium and high pressure braided and spiral hoses:

FORZA UNO R1AT/1SN; FORZA UNO "SHARK SKIN" R1AT/1SN; FORZA UNO TROPIC R1AT/1SN;
FORZA DUE R2AT/2SN; FORZA DUE "SHARK SKIN" R2AT/2SN; FORZA DUE TROPIC R2AT/2SN;
BALPAC PREMIUM R16/2SC; BALPAC PREMIUM "SHARK SKIN" R16/2SC; BALPAC PREMIUM
TROPIC R16/2SC; IMPACTUS 5K; IMPACTUS 6K; BALPAC 3000 R17/1SC; BALPAC 3000 "SHARK
SKIN" R17/1SC; 2-MAX JACK; BALWASH 1W; BALWASH 2W; BALMASTER BESTFLEX R12;
BALMASTER BESTFLEX 4SP; POWERSPIR BESTFLEX 4SH; POWERSPIR BESTFLEX R13 (3/4" &
1"); POWERSPIR BESTFLEX R15 (3/4" & 1")



Female ORFS Swivel - OFT

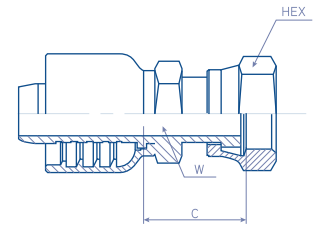

BW23.44H4.

ISO 12151-1 / ISO 8434-3 / SAE J1453

REFERENCE	#	hose		thread	dimensions		
		dash	inch		C - Cut Off	W	HEX
BW2304-04OFT	BW23.44H4.0404	04	1/4"	9/16"-18	30,2	14	17
BW2304-06OFT	BW23.44H4.0406	04	1/4"	11/16"-18	32,4	17	22
BW2306-04OFT	BW23.44H4.0604	06	3/8"	9/16"-18	29,3	17	17
BW2306-06OFT	BW23.44H4.0606	06	3/8"	11/16"-16	32,3	17	22
BW2306-08OFT	BW23.44H4.0608	06	3/8"	13/16"-16	35,3	19	24
BW2308-06OFT	BW23.44H4.0806	08	1/2"	11/16"-18	34,7	19	22
BW2308-08OFT	BW23.44H4.0808	08	1/2"	13/16"-16	36,7	19	24
BW2308-10OFT	BW23.44H4.0810	08	1/2"	1"-14	42,7	24	30
BW2308-12OFT	BW23.44H4.0812	08	1/2"	1.3/16"-12	45,5	30	36
BW2310-08OFT	BW23.44H4.1008	10	5/8"	13/16"-16	39,8	22	24
BW2310-10OFT	BW23.44H4.1010	10	5/8"	1"-14	43,8	24	30
BW2310-12OFT	BW23.44H4.1012	10	5/8"	1.3/16"-12	47,3	28	36
BW2312-10OFT	BW23.44H4.1210	12	3/4"	1"-14	44,8	28	30
BW2312-12OFT	BW23.44H4.1212	12	3/4"	1.3/16"-12	46,8	30	36
BW2312-16OFT	BW23.44H4.1216	12	3/4"	1.7/16"-12	51,3	35	41
BW2316-12OFT	BW23.44H4.1612	16	1"	1.3/16"-12	49,2	35	36
BW2316-16OFT	BW23.44H4.1616	16	1"	1.7/16"-12	51,3	35	41
BW2316-20OFT	BW23.44H4.1620	16	1"	1.11/16"-12	52,2	41	50
BW2320-20OFT	BW23.44H4.2020	20	1.1/4"	1.11/16"-12	52,5	41	50
BW2320-24OFT	BW23.44H4.2024	20	1.1/4"	2"-12	55,0	50	60
BW2324-24OFT	BW23.44H4.2424	24	1.1/2"	2"-12	58,4	50	60

MATERIAL: Carbon Steel

FINISH: Chromium-(VI) Free plating /
ROHS compliant

Suitable to be used on medium and high pressure braided and spiral hoses:

FORZA UNO R1AT/1SN; FORZA UNO "SHARK SKIN" R1AT/1SN; FORZA UNO TROPIC R1AT/1SN;
FORZA DUE R2AT/2SN; FORZA DUE "SHARK SKIN" R2AT/2SN; FORZA DUE TROPIC R2AT/2SN;
BALPAC PREMIUM R16/2SC; BALPAC PREMIUM "SHARK SKIN" R16/2SC; BALPAC PREMIUM
TROPIC R16/2SC; IMPACTUS 5K; IMPACTUS 6K; BALPAC 3000 R17/1SC; BALPAC 3000 "SHARK
SKIN" R17/1SC; 2-MAX JACK; BALWASH 1W; BALWASH 2W; BALMASTER BESTFLEX R12;
BALMASTER BESTFLEX 4SP; POWERSPIR BESTFLEX 4SH; POWERSPIR BESTFLEX R13 (3/4" &
1"); POWERSPIR BESTFLEX R15 (3/4" & 1")

Female ORFS Swivel 45° Elbow- OFT45

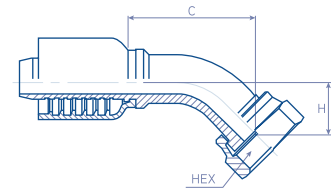

BW23.4444.

ISO 12151-1 / ISO 8434-3 / SAE J1453

REFERENCE	#	hose		thread	dimensions		
		dash	inch		C - Cut Off	H	HEX
BW2304-04OF45	BW23.4444.0404	04	1/4"	9/16"-18	35	10	17
BW2304-06OF45	BW23.4444.0406	04	1/4"	11/16"-16	35	11	22
BW2306-04OF45	BW23.4444.0604	06	3/8"	9/16"-18	40	15	17
BW2306-06OF45	BW23.4444.0606	06	3/8"	11/16"-16	40	13,5	22
BW2306-08OF45	BW23.4444.0608	06	3/8"	13/16"-16	40	15	24
BW2308-06OF45	BW23.4444.0806	08	1/2"	11/16"-16	46	18,5	24
BW2308-08OF45	BW23.4444.0808	08	1/2"	13/16"-16	43	15	24
BW2308-10OF45	BW23.4444.0810	08	1/2"	1"-14	45	16	30
BW2308-12OF45	BW23.4444.0812	08	1/2"	1.3/16"-12	54	21	36
BW2310-10OF45	BW23.4444.1010	10	5/8"	1"-14	50	18	30
BW2310-12OF45	BW23.4444.1012	10	5/8"	1.3/16"-12	55	21	36
BW2312-12OF45	BW23.4444.1212	12	3/4"	1.3/16"-12	65	21	36
BW2312-16OF45	BW23.4444.1216	12	3/4"	1.7/16"-12	74	25	41
BW2316-12OF45	BW23.4444.1612	16	1"	1.3/16"-12	75	25	36
BW2316-16OF45	BW23.4444.1616	16	1"	1.7/16"-12	76	25	41
BW2316-20OF45	BW23.4444.1620	16	1"	1.11/16"-12	81	33	50
BW2320-20OF45	BW23.4444.2020	20	1.1/4"	1.11/16"-12	94	32	50
BW2320-24OF45	BW23.4444.2024	20	1.1/4"	2"-12	102	38	60
BW2324-24OF45	BW23.4444.2424	24	1.1/2"	2"-12	123	44	60

MATERIAL: Carbon Steel

FINISH: Chromium-(VI) Free plating /
ROHS compliant

Suitable to be used on medium and high pressure braided and spiral hoses:

FORZA UNO R1AT/1SN; FORZA UNO "SHARK SKIN" R1AT/1SN; FORZA UNO TROPIC R1AT/1SN; FORZA DUE R2AT/2SN; FORZA DUE "SHARK SKIN" R2AT/2SN; FORZA DUE TROPIC R2AT/2SN; BALPAC PREMIUM R16/2SC; BALPAC PREMIUM "SHARK SKIN" R16/2SC; BALPAC PREMIUM TROPIC R16/2SC; IMPACTUS 5K; IMPACTUS 6K; BALPAC 3000 R17/1SC; BALPAC 3000 "SHARK SKIN" R17/1SC; 2-MAX JACK; BALWASH 1W; BALWASH 2W; BALMASTER BESTFLEX R12; BALMASTER BESTFLEX 4SP; POWERSPIR BESTFLEX 4SH; POWERSPIR BESTFLEX R13 (3/4" & 1"); POWERSPIR BESTFLEX R15 (3/4" & 1")



Female ORFS Swivel 90° Elbow - OFT90

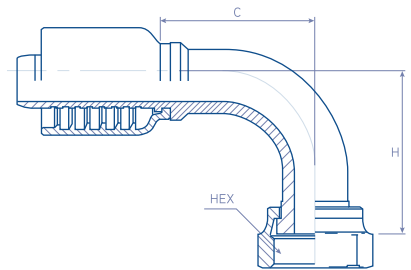

BW23.4494.

ISO 12151-1 / ISO 8434-3 / SAE J1453

REFERENCE	#	hose		thread	dimensions		
		dash	inch		C - Cut Off	H	HEX
BW2304-04OF90	BW23.4494.0404	04	1/4"	9/16"-18	33,0	21,0	17
BW2304-06OF90	BW23.4494.0406	04	1/4"	11/16"-16	33,0	23,0	22
BW2306-04OF90	BW23.4494.0604	06	1/4"	9/16"-18	34,5	27,0	17
BW2306-06OF90	BW23.4494.0606	06	3/8"	11/16"-16	34,5	29,0	22
BW2306-08OF90	BW23.4494.0608	06	3/8"	13/16"-16	37,0	30,0	24
BW2308-06OF90	BW23.4494.0806	08	1/2"	11/16"-16	39,5	34,0	22
BW2308-08OF90	BW23.4494.0808	08	1/2"	13/16"-16	39,5	35,0	24
BW2308-10OF90	BW23.4494.0810	08	1/2"	1"-14	39,5	36,5	30
BW2308-12OF90	BW23.4494.0812	08	1/2"	1.3/16"-12	42,0	45,0	36
BW2310-08OF90	BW23.4494.1008	10	5/8"	13/16"-16	45,0	30,0	24
BW2310-10OF90	BW23.4494.1010	10	5/8"	1"-14	54,0	40,0	30
BW2310-12OF90	BW23.4494.1012	10	5/8"	1.3/16"-12	54,0	48,0	36
BW2312-12OF90	BW23.4494.1212	12	3/4"	1.3/16"-12	57,0	48,0	36
BW2312-16OF90	BW23.4494.1216	12	3/4"	1.7/16"-12	57,0	56,0	41
BW2316-12OF90	BW23.4494.1612	16	1"	1.3/16"-12	65,0	58,0	36
BW2316-16OF90	BW23.4494.1616	16	1"	1.7/16"-12	70,0	60,0	41
BW2316-20OF90	BW23.4494.1620	16	1"	1.11/16"-12	74,0	77,0	50
BW2320-20OF90	BW23.4494.2020	20	1.1/4"	1.11/16"-12	88,0	77,0	50
BW2320-24OF90	BW23.4494.2024	20	1.1/4"	2"-12	96,0	85,0	60
BW2324-24OF90	BW23.4494.2424	24	1.1/2"	2"-12	105,0	85,0	60

MATERIAL: Carbon Steel

FINISH: Chromium-(VI) Free plating /
ROHS compliant

Suitable to be used on medium and high pressure braided and spiral hoses:

FORZA UNO R1AT/1SN; FORZA UNO "SHARK SKIN" R1AT/1SN; FORZA UNO TROPIC R1AT/1SN;
FORZA DUE R2AT/2SN; FORZA DUE "SHARK SKIN" R2AT/2SN; FORZA DUE TROPIC R2AT/2SN;
BALPAC PREMIUM R16/2SC; BALPAC PREMIUM "SHARK SKIN" R16/2SC; BALPAC PREMIUM
TROPIC R16/2SC; IMPACTUS 5K; IMPACTUS 6K; BALPAC 3000 R17/1SC; BALPAC 3000 "SHARK
SKIN" R17/1SC; 2-MAX JACK; BALWASH 1W; BALWASH 2W; BALMASTER BESTFLEX R12;
BALMASTER BESTFLEX 4SP; POWERSPIR BESTFLEX 4SH; POWERSPIR BESTFLEX R13 (3/4" &
1"); POWERSPIR BESTFLEX R15 (3/4" & 1")

Female ORFS Swivel 90° Long Elbow - OFT90

BW23.4494-L.

ISO 12151-1 / ISO 8434-3 / SAE J1453

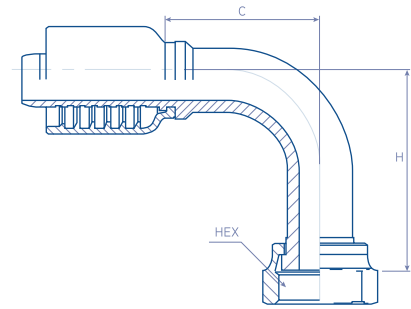

REFERENCE	#	hose		thread	dimensions		
		dash	inch		C - Cut Off	H	HEX
BW2304-04OF90L	BW23.4494.0404L	04	1/4"	9/16"-18	21,0	46,0	17
BW2306-06OF90L	BW23.4494.0606L	06	3/8"	11/16"-16	35,5	54,0	22
BW2306-08OF90L	BW23.4494.0608L	06	3/8"	13/16"-16	37,0	64,0	24
BW2308-08OF90L	BW23.4494.0808L	08	1/2"	13/16"-16	40,0	64,0	24
BW2310-10OF90L	BW23.4494.1010L	10	5/8"	1"-14	53,5	70,0	30
BW2312-12OF90L	BW23.4494.1212L	12	3/4"	1.3/16"-12	57,0	96,0	36
BW2316-16OF90L	BW23.4494.1616L	16	1"	1.7/16"-12	70,3	114,0	41

MATERIAL: Carbon Steel

FINISH: Chromium-(VI) Free plating /
ROHS compliant

Suitable to be used on medium and high pressure braided and spiral hoses:

FORZA UNO R1AT/1SN; FORZA UNO "SHARK SKIN" R1AT/1SN; FORZA UNO TROPIC R1AT/1SN;
FORZA DUE R2AT/2SN; FORZA DUE "SHARK SKIN" R2AT/2SN; FORZA DUE TROPIC R2AT/2SN;
BALPAC PREMIUM R16/2SC; BALPAC PREMIUM "SHARK SKIN" R16/2SC; BALPAC PREMIUM
TROPIC R16/2SC; IMPACTUS 5K; IMPACTUS 6K; BALPAC 3000 R17/1SC; BALPAC 3000 "SHARK
SKIN" R17/1SC; 2-MAX JACK; BALWASH 1W; BALWASH 2W; BALMASTER BESTFLEX R12;
BALMASTER BESTFLEX 4SP; POWERSPIR BESTFLEX 4SH; POWERSPIR BESTFLEX R13 (3/4" &
1"); POWERSPIR BESTFLEX R15 (3/4" & 1")



Male ORFS - OFTM

BW23.4000.

ISO 12151-1 / ISO 8434-3 / SAE J1453

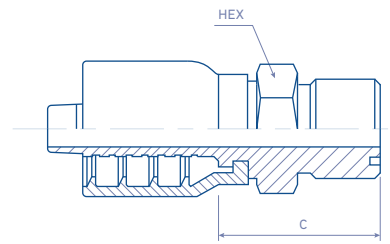

REFERENCE	#	hose		thread	dimensions	
		dash	inch		C - Cut Off	HEX
BW2304-04OFTM	BW23.4000.0404	04	1/4"	9/16"-18	24,9	17
BW2304-06OFTM	BW23.4000.0406	04	1/4"	1.1/16"-16	26,2	19
BW2306-06OFTM	BW23.4000.0606	06	3/8"	11/16"-16	26,0	19
BW2306-08OFTM	BW23.4000.0608	06	3/8"	13/16"-16	27,5	22
BW2308-08OFTM	BW23.4000.0808	08	1/2"	13/16"-16	29,7	22
BW2308-10OFTM	BW23.4000.0810	08	1/2"	1"-14	34,0	27
BW2308-12OFTM	BW23.4000.0812	08	1/2"	1.3/16"-12	38,2	32
BW2310-10OFTM	BW23.4000.1010	10	5/8"	1"-14	36,0	27
BW2310-12OFTM	BW23.4000.1012	10	5/8"	1.3/16"-12	38,5	32
BW2312-12OFTM	BW23.4000.1212	12	3/4"	1.3/16"-12	37,7	32
BW2312-16OFTM	BW23.4000.1216	12	3/4"	1.7/16"-12	42,2	41
BW2316-16OFTM	BW23.4000.1616	16	1"	1.7/16"-12	42,7	41
BW2320-20OFTM	BW23.4000.2020	20	1.1/4"	1.11/16"-12	40,5	46
BW2324-24OFTM	BW23.4000.2424	24	1.1/2"	2"-12	41,6	55

MATERIAL: Carbon Steel

FINISH: Chromium-(VI) Free plating /
ROHS compliant

Suitable to be used on medium and high pressure braided and spiral hoses:

FORZA UNO R1AT/1SN; FORZA UNO "SHARK SKIN" R1AT/1SN; FORZA UNO TROPIC R1AT/1SN; FORZA DUE R2AT/2SN; FORZA DUE "SHARK SKIN" R2AT/2SN; FORZA DUE TROPIC R2AT/2SN; BALPAC PREMIUM R16/2SC; BALPAC PREMIUM "SHARK SKIN" R16/2SC; BALPAC PREMIUM TROPIC R16/2SC; IMPACTUS 5K; IMPACTUS 6K; BALPAC 3000 R17/1SC; BALPAC 3000 "SHARK SKIN" R17/1SC; 2-MAX JACK; BALWASH 1W; BALWASH 2W; BALMASTER BESTFLEX R12; BALMASTER BESTFLEX 4SP; POWERSPIR BESTFLEX 4SH; POWERSPIR BESTFLEX R13 (3/4" & 1"); POWERSPIR BESTFLEX R15 (3/4" & 1")

SAE Inverted 45° Flare Male - MSAE

BW23.2210.

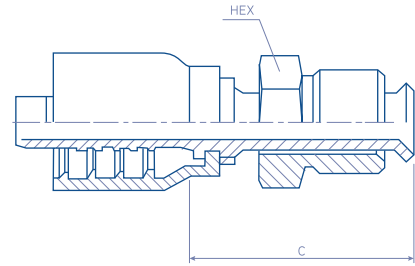

REFERENCE	#	hose		thread	dimensions	
		dash	inch		C - Cut Off	HEX
BW2304-04-M-SAE	BW23.2210.0404	04	1/4"	7/16" - 24UNS	42,0	11
BW2304-05-M-SAE	BW23.2210.0405	04	1/4"	1/2" - 20UNF	47,0	13
BW2304-06-M-SAE	BW23.2210.0406	04	1/4"	5/8" - 18UNF	46,0	16
BW2306-04-M-SAE	BW23.2210.0604	04	3/8"	7/16" - 24UNS	42,0	11
BW2306-05-M-SAE	BW23.2210.0605	06	3/8"	1/2" - 20UNF	44,0	13
BW2306-06-M-SAE	BW23.2210.0606	06	3/8"	5/8" - 18UNF	46,0	16
BW2308-08-M-SAE	BW23.2210.0808	08	1/2"	3/4" - 18UNS	47,0	19

MATERIAL: Carbon Steel

FINISH: Chromium-(VI) Free plating /
ROHS compliant

Suitable to be used on medium and high pressure braided and spiral hoses:

FORZA UNO R1AT/1SN; FORZA UNO "SHARK SKIN" R1AT/1SN; FORZA UNO TROPIC R1AT/1SN;
FORZA DUE R2AT/2SN; FORZA DUE "SHARK SKIN" R2AT/2SN; FORZA DUE TROPIC R2AT/2SN;
BALPAC PREMIUM R16/2SC; BALPAC PREMIUM "SHARK SKIN" R16/2SC; BALPAC PREMIUM
TROPIC R16/2SC; IMPACTUS 5K; IMPACTUS 6K; BALPAC 3000 R17/1SC; BALPAC 3000 "SHARK
SKIN" R17/1SC; 2-MAX JACK; BALWASH 1W; BALWASH 2W; BALMASTER BESTFLEX R12;
BALMASTER BESTFLEX 4SP



SAE Inverted 45° Flare 45° Elbow Male - MSAE 45

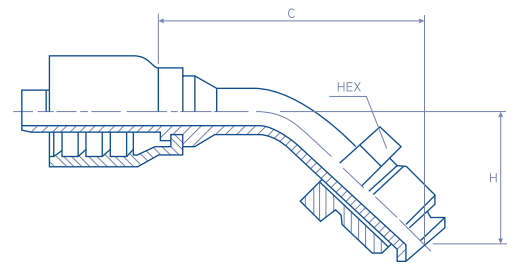

BW23.2240.

REFERENCE	#	hose		thread	dimensions		
		dash	inch		C - Cut Off	H	HEX
BW2304-04-M-SAE45	BW23.2240.0404	04	1/4"	7/16" - 24UNS	36,0	16,0	11
BW2304-05-M-SAE45	BW23.2240.0405	04	1/4"	1/2" - 20UNF	40,0	18,0	13
BW2306-04-M-SAE45	BW23.2240.0604	04	3/8"	7/16" - 24UNS	36,0	16,0	11
BW2306-05-M-SAE45	BW23.2240.0605	06	3/8"	1/2" - 20UNF	37,0	18,0	13
BW2306-06-M-SAE45	BW23.2240.0606	06	3/8"	5/8" - 18UNF	48,0	22,0	16
BW2308-08-M-SAE45	BW23.2240.0808	08	1/2"	3/4" - 18UNS	50,0	26,0	19

MATERIAL: Carbon Steel

FINISH: Chromium-(VI) Free plating /
ROHS compliant

Suitable to be used on medium and high pressure braided and spiral hoses:

FORZA UNO R1AT/1SN; FORZA UNO "SHARK SKIN" R1AT/1SN; FORZA UNO TROPIC R1AT/1SN;
FORZA DUE R2AT/2SN; FORZA DUE "SHARK SKIN" R2AT/2SN; FORZA DUE TROPIC R2AT/2SN;
BALPAC PREMIUM R16/2SC; BALPAC PREMIUM "SHARK SKIN" R16/2SC; BALPAC PREMIUM
TROPIC R16/2SC; IMPACTUS 5K; IMPACTUS 6K; BALPAC 3000 R17/1SC; BALPAC 3000 "SHARK
SKIN" R17/1SC; 2-MAX JACK; BALWASH 1W; BALWASH 2W; BALMASTER BESTFLEX R12;
BALMASTER BESTFLEX 4SP

SAE Inverted 45° Flare 90° Elbow Male - MSAE 90

BW23.2290.



REFERENCE	#	hose		thread	dimensions		
		dash	inch		C - Cut Off	H	HEX
BW2304-04-M-SAE90	BW23.2290.0404	04	1/4"	7/16" - 24UNS	36,0	40,0	11
BW2304-05-M-SAE90	BW23.2290.0405	04	1/4"	1/2" - 20UNF	42,0	40,0	13
BW2304-06-M-SAE90	BW23.2290.0406	04	1/4"	5/8" - 18UNF	40,0	40,0	16
BW2306-04-M-SAE90	BW23.2290.0604	04	3/8"	7/16" - 24UNS	37,0	40,0	11
BW2306-05-M-SAE90	BW23.2290.0605	06	3/8"	1/2" - 20UNF	40,0	40,0	13
BW2306-06-M-SAE90	BW23.2290.0606	06	3/8"	5/8" - 18UNF	40,0	40,0	16
BW2308-08-M-SAE90	BW23.2290.0808	08	1/2"	3/4" - 18UNS	40,0	46,0	19

MATERIAL: Carbon Steel

FINISH: Chromium-(VI) Free plating /
ROHS compliant

Suitable to be used on medium and high pressure braided and spiral hoses:

FORZA UNO R1AT/1SN; FORZA UNO "SHARK SKIN" R1AT/1SN; FORZA UNO TROPIC R1AT/1SN;
FORZA DUE R2AT/2SN; FORZA DUE "SHARK SKIN" R2AT/2SN; FORZA DUE TROPIC R2AT/2SN;
BALPAC PREMIUM R16/2SC; BALPAC PREMIUM "SHARK SKIN" R16/2SC; BALPAC PREMIUM
TROPIC R16/2SC; IMPACTUS 5K; IMPACTUS 6K; BALPAC 3000 R17/1SC; BALPAC 3000 "SHARK
SKIN" R17/1SC; 2-MAX JACK; BALWASH 1W; BALWASH 2W; BALMASTER BESTFLEX R12;
BALMASTER BESTFLEX 4SP



Straight SAE 3000 PSI Code 61 Flange - PA

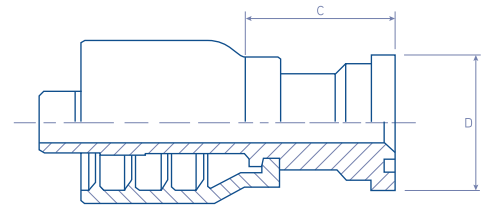

BW23.7013.

SAE J516 (CODE 61) / SAE J518 / ISO 12151-3

REFERENCE	#	hose		flange size	dimensions	
		dash	inch		C - Cut Off	D
BW2308-08PA	BW23.7013.0808	08	1/2"	1/2"	47,0	30,2
BW2308-12PA	BW23.7013.0812	08	1/2"	3/4"	48,0	38,1
BW2310-10PA	BW23.7013.1010	10	5/8"	5/8"	58,0	34,0
BW2310-12PA	BW23.7013.1012	10	5/8"	3/4"	44,0	38,1
BW2312-12PA	BW23.7013.1212	12	3/4"	3/4"	48,8	38,1
BW2312-16PA	BW23.7013.1216	12	3/4"	1"	52,0	44,5
BW2316-16PA	BW23.7013.1616	16	1"	1"	56,0	44,5
BW2316-20PA	BW23.7013.1620	16	1"	1.1/4"	60,4	50,8
BW2320-20PA	BW23.7013.2020	20	1.1/4"	1.1/4"	57,0	50,8
BW2320-24PA	BW23.7013.2024	20	1.1/4"	1.1/2"	64,0	60,3
BW2324-20PA	BW23.7013.2420	24	1.1/2"	1.1/4"	67,0	50,8
BW2324-24PA	BW23.7013.2424	24	1.1/2"	1.1/2"	69,0	60,3
BW2324-32PA	BW23.7013.2432	24	1.1/2"	2"	70,0	71,4
BW2332-32PA	BW23.7013.3232	32	2"	2"	72,0	71,4

MATERIAL: Carbon Steel

FINISH: Chromium-(VI) Free plating /
ROHS compliant

Suitable to be used on medium and high pressure braided and spiral hoses:

FORZA UNO R1AT/1SN; FORZA UNO "SHARK SKIN" R1AT/1SN; FORZA UNO TROPIC R1AT/1SN;
FORZA DUE R2AT/2SN; FORZA DUE "SHARK SKIN" R2AT/2SN; FORZA DUE TROPIC R2AT/2SN;
BALPAC PREMIUM R16/2SC; BALPAC PREMIUM "SHARK SKIN" R16/2SC; BALPAC PREMIUM
TROPIC R16/2SC; IMPACTUS 5K; IMPACTUS 6K; BALPAC 3000 R17/1SC; BALPAC 3000 "SHARK
SKIN" R17/1SC; 2-MAX JACK; BALWASH 1W; BALWASH 2W; BALMASTER BESTFLEX R12;
BALMASTER BESTFLEX 4SP; POWERSPIR BESTFLEX 4SH; POWERSPIR BESTFLEX R13 (3/4" &
1"); POWERSPIR BESTFLEX R15 (3/4" & 1")

45° Elbow SAE 3000 PSI Code 61 Flange - PA45

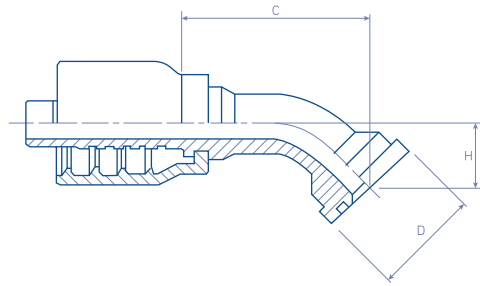

BW23.7043.

SAE J516 (CODE 61) / SAE J518 / ISO 12151-3

REFERENCE	#	hose		flange size	dimensions		
		dash	inch		C - Cut Off	H	D
BW2308-08PA45	BW23.7043.0808	08	1/2"	1/2"	57,0	23,0	30,2
BW2308-12PA45	BW23.7043.0812	08	1/2"	3/4"	63,0	30,0	38,1
BW2310-10PA45	BW23.7043.1010	10	5/8"	5/8"	68,0	27,0	34,0
BW2312-12PA45	BW23.7043.1212	12	3/4"	3/4"	69,0	28,0	38,1
BW2312-16PA45	BW23.7043.1216	12	3/4"	1"	77,0	32,0	44,5
BW2316-16PA45	BW23.7043.1616	16	1"	1"	79,0	31,0	44,5
BW2316-20PA45	BW23.7043.1620	16	1"	1.1/4"	93,0	38,0	50,8
BW2320-20PA45	BW23.7043.2020	20	1.1/4"	1.1/4"	108,0	41,0	50,8
BW2320-24PA45	BW23.7043.2024	20	1.1/4"	1.1/2"	99,0	47,0	60,3
BW2324-24PA45	BW23.7043.2424	24	1.1/2"	1.1/2"	125,0	47,0	60,3
BW2324-32PA45	BW23.7043.2432	24	1.1/2"	2"	115,0	42,0	71,4
BW2332-32PA45	BW23.7043.3232	32	2"	2"	155,0	64,0	71,4

MATERIAL: Carbon Steel

FINISH: Chromium-(VI) Free plating /
ROHS compliant

Suitable to be used on medium and high pressure braided and spiral hoses:

FORZA UNO R1AT/1SN; FORZA UNO "SHARK SKIN" R1AT/1SN; FORZA UNO TROPIC R1AT/1SN;
FORZA DUE R2AT/2SN; FORZA DUE "SHARK SKIN" R2AT/2SN; FORZA DUE TROPIC R2AT/2SN;
BALPAC PREMIUM R16/2SC; BALPAC PREMIUM "SHARK SKIN" R16/2SC; BALPAC PREMIUM
TROPIC R16/2SC; IMPACTUS 5K; IMPACTUS 6K; BALPAC 3000 R17/1SC; BALPAC 3000 "SHARK
SKIN" R17/1SC; 2-MAX JACK; BALWASH 1W; BALWASH 2W; BALMASTER BESTFLEX R12;
BALMASTER BESTFLEX 4SP; POWERSPIR BESTFLEX 4SH; POWERSPIR BESTFLEX R13 (3/4" &
1"); POWERSPIR BESTFLEX R15 (3/4" & 1")



90° Elbow SAE 3000 PSI Code 61 Flange - PA90

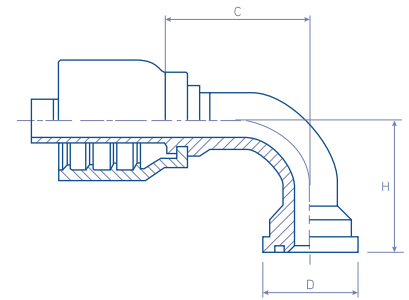

BW23.7093.

SAE J516 (CODE 61) / SAE J518 / ISO 12151-3

REFERENCE	#	hose		flange size	dimensions		
		dash	inch		C - Cut Off	H	D
BW2308-08PA90	BW23.7093.0808	08	1/2"	1/2"	48,0	41,0	30,2
BW2308-12PA90	BW23.7093.0812	08	1/2"	3/4"	50,0	48,0	38,1
BW2310-12PA90	BW23.7093.1012	10	5/8"	3/4"	55,0	55,0	38,1
BW2312-12PA90	BW23.7093.1212	12	3/4"	3/4"	60,0	60,0	38,1
BW2312-16PA90	BW23.7093.1216	12	3/4"	1"	65,0	60,0	44,5
BW2316-16PA90	BW23.7093.1616	16	1"	1"	73,0	61,0	44,5
BW2316-20PA90	BW23.7093.1620	16	1"	1.1/4"	73,0	61,0	50,8
BW2320-20PA90	BW23.7093.2020	20	1.1/4"	1.1/4"	93,0	69,0	50,8
BW2320-24PA90	BW23.7093.2024	20	1.1/4"	1.1/2"	98,0	70,0	60,3
BW2324-24PA90	BW23.7093.2424	24	1.1/2"	1.1/2"	105,0	83,0	60,3
BW2324-32PA90	BW23.7093.2432	24	1.1/2"	2"	105,0	83,0	71,4
BW2332-32PA90	BW23.7093.3232	32	2"	2"	125,0	130,0	71,4

MATERIAL: Carbon Steel

FINISH: Chromium-(VI) Free plating /
ROHS compliant

Suitable to be used on medium and high pressure braided and spiral hoses:

FORZA UNO R1AT/1SN; FORZA UNO "SHARK SKIN" R1AT/1SN; FORZA UNO TROPIC R1AT/1SN;
FORZA DUE R2AT/2SN; FORZA DUE "SHARK SKIN" R2AT/2SN; FORZA DUE TROPIC R2AT/2SN;
BALPAC PREMIUM R16/2SC; BALPAC PREMIUM "SHARK SKIN" R16/2SC; BALPAC PREMIUM
TROPIC R16/2SC; IMPACTUS 5K; IMPACTUS 6K; BALPAC 3000 R17/1SC; BALPAC 3000 "SHARK
SKIN" R17/1SC; 2-MAX JACK; BALWASH 1W; BALWASH 2W; BALMASTER BESTFLEX R12;
BALMASTER BESTFLEX 4SP; POWERSPIR BESTFLEX 4SH; POWERSPIR BESTFLEX R13 (3/4" &
1"); POWERSPIR BESTFLEX R15 (3/4" & 1")

Straight SAE 6000 PSI Code 62 Flange - PH

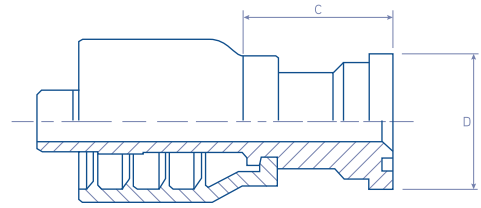

BW23.7016.

SAE J516 (CODE 62) / SAE J518 / ISO 12151-3

REFERENCE	#	hose		flange size	dimensions	
		dash	inch		C - Cut Off	D
BW2308-08PH	BW23.7016.0808	08	1/2"	1/2"	48,0	31,7
BW2308-12PH	BW23.7016.0812	08	1/2"	3/4"	51,0	41,3
BW2310-12PH	BW23.7016.1012	10	5/8"	3/4"	50,0	41,3
BW2312-12PH	BW23.7016.1212	12	3/4"	3/4"	52,0	41,3
BW2312-16PH	BW23.7016.1216	12	3/4"	1"	56,8	47,6
BW2316-16PH	BW23.7016.1616	16	1"	1"	56,7	47,6
BW2316-20PH	BW23.7016.1620	16	1"	1.1/4"	64,7	54
BW2320-20PH	BW23.7016.2020	20	1.1/4"	1.1/4"	65,0	54
BW2320-24PH	BW23.7016.2024	20	1.1/4"	1.1/2"	73,0	63,5
BW2324-24PH	BW23.7016.2424	24	1.1/2"	1.1/2"	75,0	63,5
BW2324-32PH	BW23.7016.2432	24	1.1/2"	2"	70,0	79,4
BW2332-32PH	BW23.7016.3232	32	2"	2"	87,6	79,4

MATERIAL: Carbon Steel

FINISH: Chromium-(VI) Free plating /
ROHS compliant

Suitable to be used on medium and high pressure braided and spiral hoses:

FORZA UNO R1AT/1SN; FORZA UNO "SHARK SKIN" R1AT/1SN; FORZA UNO TROPIC R1AT/1SN;
FORZA DUE R2AT/2SN; FORZA DUE "SHARK SKIN" R2AT/2SN; FORZA DUE TROPIC R2AT/2SN;
BALPAC PREMIUM R16/2SC; BALPAC PREMIUM "SHARK SKIN" R16/2SC; BALPAC PREMIUM
TROPIC R16/2SC; IMPACTUS 5K; IMPACTUS 6K; BALPAC 3000 R17/1SC; BALPAC 3000 "SHARK
SKIN" R17/1SC; 2-MAX JACK; BALWASH 1W; BALWASH 2W; BALMASTER BESTFLEX R12;
BALMASTER BESTFLEX 4SP; POWERSPIR BESTFLEX 4SH; POWERSPIR BESTFLEX R13 (3/4" &
1"); POWERSPIR BESTFLEX R15 (3/4" & 1")



45° Elbow SAE 6000 PSI Code 62 Flange - PH45

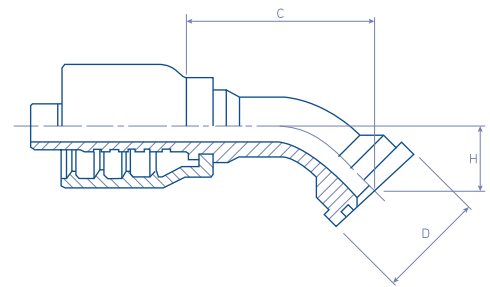

BW23.7046.

SAE J516 (CODE 62) / SAE J518 / ISO 12151-3

REFERENCE	#	hose		flange size	dimensions		
		dash	inch		C - Cut Off	H	D
BW2308-08PH45	BW23.7046.0808	08	1/2"	1/2"	57,0	23,0	31,7
BW2308-12PH45	BW23.7046.0812	08	1/2"	3/4"	63,0	30,0	41,3
BW2310-12PH45	BW23.7046.1012	10	5/8"	3/4"	68,0	27,0	41,3
BW2312-12PH45	BW23.7046.1212	12	3/4"	3/4"	69,0	28,0	41,3
BW2312-16PH45	BW23.7046.1216	12	3/4"	1"	77,0	32,0	47,6
BW2316-16PH45	BW23.7046.1616	16	1"	1"	79,0	31,0	47,6
BW2316-20PH45	BW23.7046.1620	16	1"	1.1/4"	93,0	38,0	54
BW2320-20PH45	BW23.7046.2020	20	1.1/4"	1.1/4"	108,0	41,0	54
BW2320-24PH45	BW23.7046.2024	20	1.1/4"	1.1/2"	112,0	47,0	63,5
BW2324-24PH45	BW23.7046.2424	24	1.1/2"	1.1/2"	125,0	47,0	63,5
BW2324-32PH45	BW23.7046.2432	24	1.1/2"	2"	134,0	58,0	79,4
BW2332-32PH45	BW23.7046.3232	32	2"	2"	155,0	64,0	79,4

MATERIAL: Carbon Steel

FINISH: Chromium-(VI) Free plating /
ROHS compliant

Suitable to be used on medium and high pressure braided and spiral hoses:

FORZA UNO R1AT/1SN; FORZA UNO "SHARK SKIN" R1AT/1SN; FORZA UNO TROPIC R1AT/1SN;
FORZA DUE R2AT/2SN; FORZA DUE "SHARK SKIN" R2AT/2SN; FORZA DUE TROPIC R2AT/2SN;
BALPAC PREMIUM R16/2SC; BALPAC PREMIUM "SHARK SKIN" R16/2SC; BALPAC PREMIUM
TROPIC R16/2SC; IMPACTUS 5K; IMPACTUS 6K; BALPAC 3000 R17/1SC; BALPAC 3000 "SHARK
SKIN" R17/1SC; 2-MAX JACK; BALWASH 1W; BALWASH 2W; BALMASTER BESTFLEX R12;
BALMASTER BESTFLEX 4SP; POWERSPIR BESTFLEX 4SH; POWERSPIR BESTFLEX R13 (3/4" &
1"); POWERSPIR BESTFLEX R15 (3/4" & 1")

90° Elbow SAE 6000 PSI Code 62 Flange - PH90

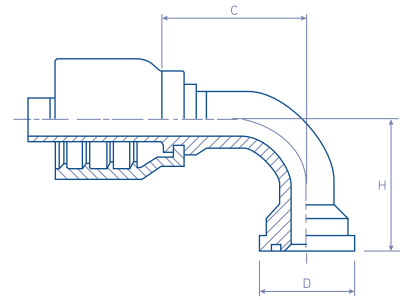

BW23.7096.

SAE J516 (CODE 62) / SAE J518 / ISO 12151-3

REFERENCE	#	hose		flange size	dimensions		
		dash	inch		C - Cut Off	H	D
BW2308-08PH90	BW23.7096.0808	08	1/2"	1/2"	50,0	47,0	31,7
BW2308-12PH90	BW23.7096.0812	08	1/2"	3/4"	46,0	56,0	41,3
BW2310-12PH90	BW23.7096.1012	10	5/8"	3/4"	54,0	58,0	41,3
BW2312-12PH90	BW23.7096.1212	12	3/4"	3/4"	60,0	58,0	41,3
BW2312-16PH90	BW23.7096.1216	12	3/4"	1"	60,0	70,0	47,6
BW2316-16PH90	BW23.7096.1616	16	1"	1"	77,0	70,0	47,6
BW2316-20PH90	BW23.7096.1620	16	1"	1.1/4"	72,0	70,0	54
BW2320-20PH90	BW23.7096.2020	20	1.1/4"	1.1/4"	97,0	79,0	54
BW2320-24PH90	BW23.7096.2024	20	1.1/4"	1.1/2"	100,0	97,0	63,5
BW2324-24PH90	BW23.7096.2424	24	1.1/2"	1.1/2"	107,0	97,0	63,5
BW2324-32PH90	BW23.7096.2432	24	1.1/2"	2"	107,0	125,0	79,4
BW2332-32PH90	BW23.7096.3232	32	2"	2"	130,0	138,0	79,4

MATERIAL: Carbon Steel

FINISH: Chromium-(VI) Free plating /
ROHS compliant

Suitable to be used on medium and high pressure braided and spiral hoses:

FORZA UNO R1AT/1SN; FORZA UNO "SHARK SKIN" R1AT/1SN; FORZA UNO TROPIC R1AT/1SN;
FORZA DUE R2AT/2SN; FORZA DUE "SHARK SKIN" R2AT/2SN; FORZA DUE TROPIC R2AT/2SN;
BALPAC PREMIUM R16/2SC; BALPAC PREMIUM "SHARK SKIN" R16/2SC; BALPAC PREMIUM
TROPIC R16/2SC; IMPACTUS 5K; IMPACTUS 6K; BALPAC 3000 R17/1SC; BALPAC 3000 "SHARK
SKIN" R17/1SC; 2-MAX JACK; BALWASH 1W; BALWASH 2W; BALMASTER BESTFLEX R12;
BALMASTER BESTFLEX 4SP; POWERSPIR BESTFLEX 4SH; POWERSPIR BESTFLEX R13 (3/4" &
1"); POWERSPIR BESTFLEX R15 (3/4" & 1")



Straight SuperCAT Flange - SC

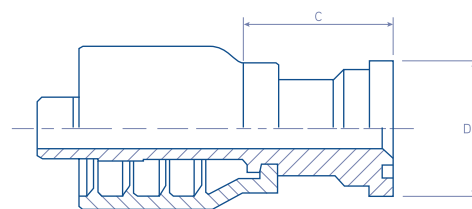

BW23.7116.

SAE J516 (CODE 62) / SAE J518 / ISO 12151-3

REFERENCE	#	hose		flange size	dimensions	
		dash	inch		C - Cut Off	D
BW2308-08SC	BW23.7116.0808	08	1/2"	1/2"	46,0	31,7
BW2308-12SC	BW23.7116.0812	08	1/2"	3/4"	46,0	41,3
BW2310-12SC	BW23.7116.1012	10	5/8"	3/4"	46,0	41,3
BW2312-12SC	BW23.7116.1212	12	3/4"	3/4"	48,0	41,3
BW2312-16SC	BW23.7116.1216	12	3/4"	1"	62,0	47,6
BW2316-16SC	BW23.7116.1616	16	1"	1"	63,0	47,6
BW2316-20SC	BW23.7116.1620	16	1"	1.1/4"	69,0	54

MATERIAL: Carbon Steel

FINISH: Chromium-(VI) Free plating /
ROHS compliant

Suitable to be used on medium and high pressure braided and spiral hoses:

FORZA UNO R1AT/1SN; FORZA UNO "SHARK SKIN" R1AT/1SN; FORZA UNO TROPIC R1AT/1SN;
FORZA DUE R2AT/2SN; FORZA DUE "SHARK SKIN" R2AT/2SN; FORZA DUE TROPIC R2AT/2SN;
BALPAC PREMIUM R16/2SC; BALPAC PREMIUM "SHARK SKIN" R16/2SC; BALPAC PREMIUM
TROPIC R16/2SC; IMPACTUS 5K; IMPACTUS 6K; BALPAC 3000 R17/1SC; BALPAC 3000 "SHARK
SKIN" R17/1SC; 2-MAX JACK; BALWASH 1W; BALWASH 2W; BALMASTER BESTFLEX R12;
BALMASTER BESTFLEX 4SP; POWERSPIR BESTFLEX 4SH; POWERSPIR BESTFLEX R13 (3/4" &
1"); POWERSPIR BESTFLEX R15 (3/4" & 1")

45° Elbow SuperCAT Flange - SC45

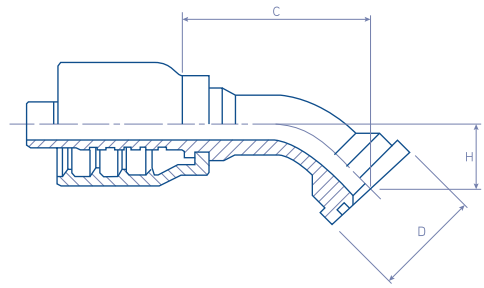

BW23.7146.

SAE J516 (CODE 62) / SAE J518 / ISO 12151-3

REFERENCE	#	hose		flange size	dimensions		
		dash	inch		C - Cut Off	H	D
BW2308-08SC45	BW23.7146.0808	08	1/2"	1/2"	57,0	23,0	31,7
BW2308-12SC45	BW23.7146.0812	08	1/2"	3/4"	63,0	30,0	41,3
BW2310-12SC45	BW23.7146.1012	10	5/8"	3/4"	68,0	28,0	41,3
BW2312-12SC45	BW23.7146.1212	12	3/4"	3/4"	70,0	32,0	41,3
BW2312-16SC45	BW23.7146.1216	12	3/4"	1"	77,0	36,0	47,6
BW2316-16SC45	BW23.7146.1616	16	1"	1"	81,0	34,0	47,6
BW2316-20SC45	BW23.7146.1620	16	1"	1.1/4"	93,0	41,0	54,0

MATERIAL: Carbon Steel

FINISH: Chromium-(VI) Free plating / ROHS compliant

Suitable to be used on medium and high pressure braided and spiral hoses:

FORZA UNO R1AT/1SN; FORZA UNO "SHARK SKIN" R1AT/1SN; FORZA UNO TROPIC R1AT/1SN; FORZA DUE R2AT/2SN; FORZA DUE "SHARK SKIN" R2AT/2SN; FORZA DUE TROPIC R2AT/2SN; BALPAC PREMIUM R16/2SC; BALPAC PREMIUM "SHARK SKIN" R16/2SC; BALPAC PREMIUM TROPIC R16/2SC; IMPACTUS 5K; IMPACTUS 6K; BALPAC 3000 R17/1SC; BALPAC 3000 "SHARK SKIN" R17/1SC; 2-MAX JACK; BALWASH 1W; BALWASH 2W; BALMASTER BESTFLEX R12; BALMASTER BESTFLEX 4SP; POWERSPIR BESTFLEX 4SH; POWERSPIR BESTFLEX R13 (3/4" & 1"); POWERSPIR BESTFLEX R15 (3/4" & 1")



90° Elbow SuperCAT Flange – SC90

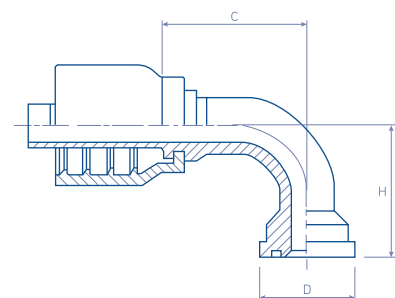

BW23.7196.

SAE J516 (CODE 62) / SAE J518 / ISO 12151-3

REFERENCE	#	hose		flange size	dimensions		
		dash	inch		C - Cut Off	H	D
BW2308-08SC90	BW23.7196.0808	08	1/2"	1/2"	47,0	47,0	31,7
BW2308-12SC90	BW23.7196.0812	08	1/2"	3/4"	50,5	56,0	41,3
BW2310-12SC90	BW23.7196.1012	10	5/8"	3/4"	53,5	58,0	41,3
BW2312-12SC90	BW23.7196.1212	12	3/4"	3/4"	55,0	60,0	41,3
BW2312-16SC90	BW23.7196.1216	12	3/4"	1"	55,0	68,0	47,6
BW2316-16SC90	BW23.7196.1616	16	1"	1"	76,0	70,0	47,6
BW2316-20SC90	BW23.7196.1620	16	1"	1.1/4"	76,0	82,0	54,0

MATERIAL: Carbon Steel

FINISH: Chromium-(VI) Free plating /
ROHS compliant

Suitable to be used on medium and high pressure braided and spiral hoses:

FORZA UNO R1AT/1SN; FORZA UNO "SHARK SKIN" R1AT/1SN; FORZA UNO TROPIC R1AT/1SN; FORZA DUE R2AT/2SN; FORZA DUE "SHARK SKIN" R2AT/2SN; FORZA DUE TROPIC R2AT/2SN; BALPAC PREMIUM R16/2SC; BALPAC PREMIUM "SHARK SKIN" R16/2SC; BALPAC PREMIUM TROPIC R16/2SC; IMPACTUS 5K; IMPACTUS 6K; BALPAC 3000 R17/1SC; BALPAC 3000 "SHARK SKIN" R17/1SC; 2-MAX JACK; BALWASH 1W; BALWASH 2W; BALMASTER BESTFLEX R12; BALMASTER BESTFLEX 4SP; POWERSPIR BESTFLEX 4SH; POWERSPIR BESTFLEX R13 (3/4" & 1"); POWERSPIR BESTFLEX R15 (3/4" & 1")

Light 24° Metric Female - DLF

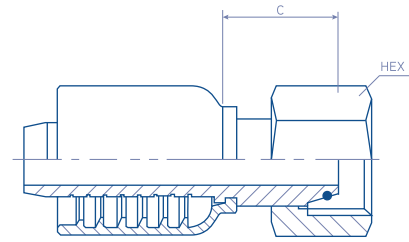

BW23.5013.

ISO 12151-2 / ISO 8434-1

REFERENCE	#	hose		thread	dimensions		
		dash	inch		d	C - Cut Off	HEX
BW2304-12DLF	BW23.5013.0412	04	1/4"	M12X1.5	6	27,7	14
BW2304-14DLF	BW23.5013.0414	04	1/4"	M14X1.5	8	25,9	17
BW2304-16DLF	BW23.5013.0416	04	1/4"	M16X1.5	10	24,9	19
BW2304-18DLF	BW23.5013.0418	04	1/4"	M18X1.5	12	26,4	22
BW2306-16DLF	BW23.5013.0616	06	3/8"	M16X1.5	10	27,2	19
BW2306-18DLF	BW23.5013.0618	06	3/8"	M18X1.5	12	25,5	22
BW2306-22DLF	BW23.5013.0622	06	3/8"	M22X1.5	12	26,0	27
BW2308-22DLF	BW23.5013.0822	08	1/2"	M22X1.5	15	27,7	27
BW2308-26DLF	BW23.5013.0826	08	1/2"	M26X1.5	18	28,7	32
BW2310-26DLF	BW23.5013.1026	10	5/8"	M26X1.5	18	30,0	32
BW2312-30DLF	BW23.5013.1230	12	3/4"	M30X2.0	22	32,3	36
BW2316-36DLF	BW23.5013.1636	16	1"	M36X2.0	28	35,8	41
BW2320-45DLF	BW23.5013.2045	20	1.1/4"	M45X2.0	35	38,9	50
BW2324-52DLF	BW23.5013.2452	24	1.1/2"	M52X2.0	42	36,9	60

MATERIAL: Carbon Steel

FINISH: Chromium-(VI) Free plating / ROHS compliant

Suitable to be used on medium and high pressure braided and spiral hoses:

FORZA UNO R1AT/1SN; FORZA UNO "SHARK SKIN" R1AT/1SN; FORZA UNO TROPIC R1AT/1SN; FORZA DUE R2AT/2SN; FORZA DUE "SHARK SKIN" R2AT/2SN; FORZA DUE TROPIC R2AT/2SN; BALPAC PREMIUM R16/2SC; BALPAC PREMIUM "SHARK SKIN" R16/2SC; BALPAC PREMIUM TROPIC R16/2SC; IMPACTUS 5K; IMPACTUS 6K; BALPAC 3000 R17/1SC; BALPAC 3000 "SHARK SKIN" R17/1SC; 2-MAX JACK; BALWASH 1W; BALWASH 2W; BALMASTER BESTFLEX R12; BALMASTER BESTFLEX 4SP; POWERSPIR BESTFLEX 4SH; POWERSPIR BESTFLEX R13 (3/4" & 1"); POWERSPIR BESTFLEX R15 (3/4" & 1")



Light 24° Metric 45° Elbow Female - DLF45

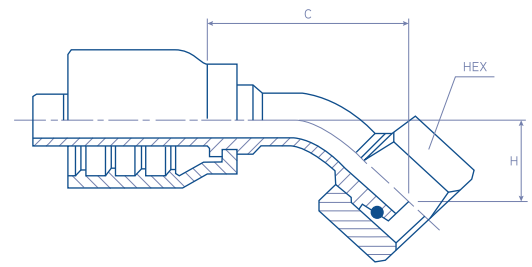

BW23.5043.

ISO 12151-2 / ISO 8434-1

REFERENCE	#	hose		thread	dimensions			
		dash	inch		d	C - Cut Off	H	HEX
BW2304-12DLF45	BW23.5043.0412	04	1/4"	M12X1.5	6	39	15	14
BW2304-14DLF45	BW23.5043.0414	04	1/4"	M14X1.5	8	42,7	17,7	17
BW2304-16DLF45	BW23.5043.0416	04	1/4"	M16X1.5	10	41,5	17,7	19
BW2304-18DLF45	BW23.5043.0418	04	1/4"	M18X1.5	12	42,0	18,3	22
BW2306-16DLF45	BW23.5043.0616	06	3/8"	M16X1.5	10	44,5	21	19
BW2306-18DLF45	BW23.5043.0618	06	3/8"	M18X1.5	12	42,5	19	22
BW2308-22DLF45	BW23.5043.0822	08	1/2"	M22X1.5	15	49,0	21,5	27
BW2308-26DLF45	BW23.5043.0826	08	1/2"	M26X1.5	18	60,0	25,0	32
BW2310-26DLF45	BW23.5043.1026	10	5/8"	M26X1.5	18	62,5	25	32
BW2312-30DLF45	BW23.5043.1230	12	3/4"	M30X2.0	22	76,0	29,5	36
BW2316-36DLF45	BW23.5043.1636	16	1"	M36X2.0	28	90,5	35	41
BW2320-45DLF45	BW23.5043.2045	20	1,1/4"	M45X2.0	35	104	40	50
BW2324-52DLF45	BW23.5043.2452	24	1,1/2"	M52X2.0	42	119	41	60

MATERIAL: Carbon Steel

FINISH: Chromium-(VI) Free plating /
ROHS compliant

Suitable to be used on medium and high pressure braided and spiral hoses:

FORZA UNO R1AT/1SN; FORZA UNO "SHARK SKIN" R1AT/1SN; FORZA UNO TROPIC R1AT/1SN;
FORZA DUE R2AT/2SN; FORZA DUE "SHARK SKIN" R2AT/2SN; FORZA DUE TROPIC R2AT/2SN;
BALPAC PREMIUM R16/2SC; BALPAC PREMIUM "SHARK SKIN" R16/2SC; BALPAC PREMIUM
TROPIC R16/2SC; IMPACTUS 5K; IMPACTUS 6K; BALPAC 3000 R17/1SC; BALPAC 3000 "SHARK
SKIN" R17/1SC; 2-MAX JACK; BALWASH 1W; BALWASH 2W; BALMASTER BESTFLEX R12;
BALMASTER BESTFLEX 4SP; POWERSPIR BESTFLEX 4SH; POWERSPIR BESTFLEX R13 (3/4" &
1"); POWERSPIR BESTFLEX R15 (3/4" & 1")

Light 24° Metric 90° Elbow Female - DLF90

BW23.5093.

ISO 12151-2 / ISO 8434-1

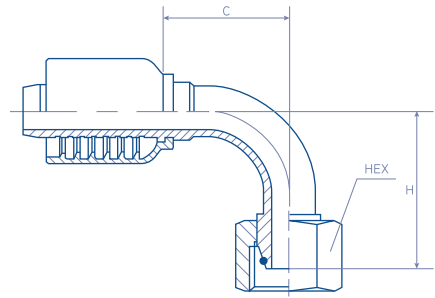

REFERENCE	#	hose		thread	dimensions			
		dash	inch		d	C - Cut Off	H	HEX
BW2304-12DLF90	BW23.5093.0412	04	1/4"	M12X1.5	6	30	30	14
BW2304-14DLF90	BW23.5093.0414	04	1/4"	M14X1.5	8	32	38	17
BW2304-16DLF90	BW23.5093.0416	04	1/4"	M16X1.5	10	31,7	38,0	19
BW2304-18DLF90	BW23.5093.0418	04	1/4"	M18X1.5	12	30,0	36,0	22
BW2306-16DLF90	BW23.5093.0616	06	3/8"	M16X1.5	10	35	36,0	19
BW2306-18DLF90	BW23.5093.0618	06	3/8"	M18X1.5	12	36	36,0	22
BW2306-22DLF90	BW23.5093.0622	06	3/8"	M22X1.5	15	34,2	36	27
BW2308-22DLF90	BW23.5093.0822	08	1/2"	M22X1.5	15	38	40,5	27
BW2308-26DLF90	BW23.5093.0826	08	1/2"	M26X1.5	18	48	51,5	32
BW2310-26DLF90	BW23.5093.1026	10	5/8"	M26X1.5	18	48	51,5	32
BW2312-30DLF90	BW23.5093.1230	12	3/4"	M30X2.0	22	54	54,5	36
BW2316-36DLF90	BW23.5093.1636	16	1"	M36X2.0	28	75	68,5	41
BW2320-45DLF90	BW23.5093.2045	20	1.1/4"	M45X2.0	35	75	81,0	50
BW2324-52DLF90	BW23.5093.2452	24	1.1/2"	M52X2.0	42	114,0	95,0	60

MATERIAL: Carbon Steel

FINISH: Chromium-(VI) Free plating / ROHS compliant

Suitable to be used on medium and high pressure braided and spiral hoses:

FORZA UNO R1AT/1SN; FORZA UNO "SHARK SKIN" R1AT/1SN; FORZA UNO TROPIC R1AT/1SN; FORZA DUE R2AT/2SN; FORZA DUE "SHARK SKIN" R2AT/2SN; FORZA DUE TROPIC R2AT/2SN; BALPAC PREMIUM R16/2SC; BALPAC PREMIUM "SHARK SKIN" R16/2SC; BALPAC PREMIUM TROPIC R16/2SC; IMPACTUS 5K; IMPACTUS 6K; BALPAC 3000 R17/1SC; BALPAC 3000 "SHARK SKIN" R17/1SC; 2-MAX JACK; BALWASH 1W; BALWASH 2W; BALMASTER BESTFLEX R12; BALMASTER BESTFLEX 4SP; POWERSPIR BESTFLEX 4SH; POWERSPIR BESTFLEX R13 (3/4" & 1"); POWERSPIR BESTFLEX R15 (3/4" & 1")



Light 24° Metric Male - DLM

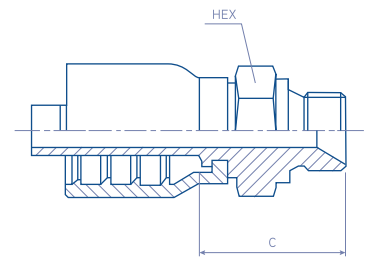

BW23.1000.

ISO 12151-2 / ISO 8434-1

REFERENCE	#	hose		thread	dimensions		
		dash	inch		d	C - Cut Off	HEX
BW2304-12DLM	BW23.1000.0412	04	1/4"	M12X1.5	6	24,2	14
BW2304-14DLM	BW23.1000.0414	04	1/4"	M14X1.5	8	24,7	17
BW2304-16DLM	BW23.1000.0416	04	1/4"	M16X1.5	10	25,7	17
BW2304-18DLM	BW23.1000.0418	04	1/4"	M18X1.5	12	26,7	19
BW2306-16DLM	BW23.1000.0616	06	3/8"	M16X1.5	10	23,7	17
BW2306-18DLM	BW23.1000.0618	06	3/8"	M18X1.5	12	24,7	19
BW2306-22DLM	BW23.1000.0622	06	3/8"	M22X1.5	15	27,7	24
BW2308-18DLM	BW23.1000.0818	08	1/2"	M18X1.5	12	26,5	19
BW2308-22DLM	BW23.1000.0822	08	1/2"	M22X1.5	15	29,5	24
BW2310-26DLM	BW23.1000.1026	10	5/8"	M26X1.5	18	32,0	27
BW2310-30DLM	BW23.1000.1030	10	5/8"	M30X2.0	22	36,0	32
BW2312-30DLM	BW23.1000.1230	12	3/4"	M30X2.0	22	35,3	32
BW2316-36DLM	BW23.1000.1636	16	1"	M36X2.0	28	38,2	41
BW2320-45DLM	BW23.1000.2045	20	1.1/4"	M45X2.0	35	42,0	46
BW2324-52DLM	BW23.1000.2452	24	1.1/2"	M52X2.0	42	46,4	55

MATERIAL: Carbon Steel

FINISH: Chromium-(VI) Free plating /
ROHS compliant

Suitable to be used on medium and high pressure braided and spiral hoses:

FORZA UNO R1AT/1SN; FORZA UNO "SHARK SKIN" R1AT/1SN; FORZA UNO TROPIC R1AT/1SN;
FORZA DUE R2AT/2SN; FORZA DUE "SHARK SKIN" R2AT/2SN; FORZA DUE TROPIC R2AT/2SN;
BALPAC PREMIUM R16/2SC; BALPAC PREMIUM "SHARK SKIN" R16/2SC; BALPAC PREMIUM
TROPIC R16/2SC; IMPACTUS 5K; IMPACTUS 6K; BALPAC 3000 R17/1SC; BALPAC 3000 "SHARK
SKIN" R17/1SC; 2-MAX JACK; BALWASH 1W; BALWASH 2W; BALMASTER BESTFLEX R12;
BALMASTER BESTFLEX 4SP; POWERSPIR BESTFLEX 4SH; POWERSPIR BESTFLEX R13 (3/4" &
1"); POWERSPIR BESTFLEX R15 (3/4" & 1")

Heavy 24° Metric Female - DHF

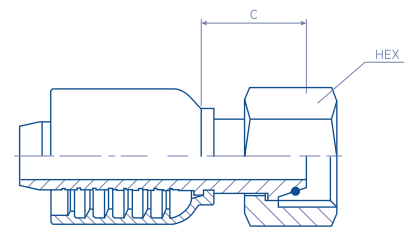

BW23.5113.

ISO 12151-2 / ISO 8434-1

REFERENCE	#	hose		thread	dimensions		
		dash	inch		d	C - Cut Off	HEX
BW2304-16DHF	BW23.5113.0416	04	1/4"	M16X1.5	8	27,0	19
BW2304-18DHF	BW23.5113.0418	04	1/4"	M18X1.5	10	27,5	22
BW2306-18DHF	BW23.5113.0618	06	3/8"	M18X1.5	10	25,5	22
BW2306-20DHF	BW23.5113.0620	06	3/8"	M20X1.5	12	25,0	24
BW2306-22DHF	BW23.5113.0622	06	3/8"	M22X1.5	14	29,5	27
BW2308-24DHF	BW23.5113.0824	08	1/2"	M24X1.5	16	31,0	30
BW2310-30DHF	BW23.5113.1030	10	5/8"	M30X2.0	20	38,4	36
BW2312-30DHF	BW23.5113.1230	12	3/4"	M30X2.0	20	37,5	36
BW2312-36DHF	BW23.5113.1236	12	3/4"	M36X2.0	25	41,8	46
BW2316-36DHF	BW23.5113.1636	16	1"	M36X2.0	25	42,5	46
BW2316-42DHF	BW23.5113.1642	16	1"	M42X2.0	30	45,7	50
BW2320-52DHF	BW23.5113.2052	20	1.1/4"	M52X2.0	38	46,0	60

MATERIAL: Carbon Steel

FINISH: Chromium-(VI) Free plating / ROHS compliant

Suitable to be used on medium and high pressure braided and spiral hoses:

FORZA UNO R1AT/1SN; FORZA UNO "SHARK SKIN" R1AT/1SN; FORZA UNO TROPIC R1AT/1SN; FORZA DUE R2AT/2SN; FORZA DUE "SHARK SKIN" R2AT/2SN; FORZA DUE TROPIC R2AT/2SN; BALPAC PREMIUM R16/2SC; BALPAC PREMIUM "SHARK SKIN" R16/2SC; BALPAC PREMIUM TROPIC R16/2SC; IMPACTUS 5K; IMPACTUS 6K; BALPAC 3000 R17/1SC; BALPAC 3000 "SHARK SKIN" R17/1SC; 2-MAX JACK; BALWASH 1W; BALWASH 2W; BALMASTER BESTFLEX R12; BALMASTER BESTFLEX 4SP; POWERSPIR BESTFLEX 4SH; POWERSPIR BESTFLEX R13 (3/4" & 1"); POWERSPIR BESTFLEX R15 (3/4" & 1")



Heavy 24° Metric 45° Elbow Female - DHF45

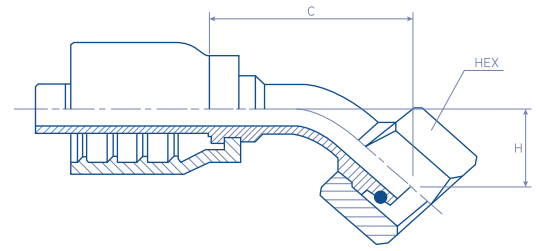

BW23.5143.

ISO 12151-2 / ISO 8434-1

REFERENCE	#	hose		thread	dimensions			
		dash	inch		d	C - Cut Off	H	HEX
BW2304-16DHF45	BW23.5143.0416	04	1/4"	M16X1.5	8	36,5	17,0	19
BW2304-18DHF45	BW23.5143.0418	04	1/4"	M18X1.5	10	40,5	16,7	22
BW2306-20DHF45	BW23.5143.0620	06	3/8"	M20X1.5	12	42,0	18,4	24
BW2306-22DHF45	BW23.5143.0622	06	3/8"	M22X1.5	14	42,4	18,7	27
BW2308-24DHF45	BW23.5143.0824	08	1/2"	M24X1.5	16	49,9	21,0	30
BW2310-30DHF45	BW23.5143.1030	10	5/8"	M30X2.0	20	59,0	25,0	36
BW2312-30DHF45	BW23.5143.1230	12	3/4"	M30X2.0	20	70,5	30,0	36
BW2312-36DHF45	BW23.5143.1236	12	3/4"	M36X2.0	25	81,5	30,5	46
BW2316-36DHF45	BW23.5143.1636	16	1"	M36X2.0	25	89,0	36,0	46
BW2316-42DHF45	BW23.5143.1642	16	1"	M42X2.0	30	89,0	38,0	50
BW2320-52DHF45	BW23.5143.2052	20	1.1/4"	M52X2.0	38	123,0	45,0	60

MATERIAL: Carbon Steel

FINISH: Chromium-(VI) Free plating /
ROHS compliant

Suitable to be used on medium and high pressure braided and spiral hoses:

FORZA UNO R1AT/1SN; FORZA UNO "SHARK SKIN" R1AT/1SN; FORZA UNO TROPIC R1AT/1SN; FORZA DUE R2AT/2SN; FORZA DUE "SHARK SKIN" R2AT/2SN; FORZA DUE TROPIC R2AT/2SN; BALPAC PREMIUM R16/2SC; BALPAC PREMIUM "SHARK SKIN" R16/2SC; BALPAC PREMIUM TROPIC R16/2SC; IMPACTUS 5K; IMPACTUS 6K; BALPAC 3000 R17/1SC; BALPAC 3000 "SHARK SKIN" R17/1SC; 2-MAX JACK; BALWASH 1W; BALWASH 2W; BALMASTER BESTFLEX R12; BALMASTER BESTFLEX 4SP; POWERSPIR BESTFLEX 4SH; POWERSPIR BESTFLEX R13 (3/4" & 1"); POWERSPIR BESTFLEX R15 (3/4" & 1")

Heavy 24° Metric 90° Elbow Female - DHF90

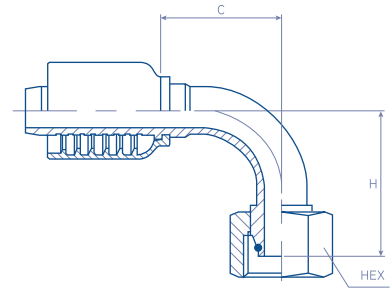

BW23.5193.

ISO 12151-2 / ISO 8434-1

REFERENCE	#	hose		thread	dimensions			
		dash	inch		d	C - Cut Off	H	HEX
BW2304-16DHF90	BW23.5193.0416	04	1/4"	M16X1.5	8	28,2	32,0	19
BW2304-18DHF90	BW23.5193.0418	04	1/4"	M18X1.5	10	31,7	32,0	22
BW2306-18DHF90	BW23.5193.0618	06	3/8"	M18X1.5	10	33,0	33,0	22
BW2306-20DHF90	BW23.5193.0620	06	3/8"	M20X1.5	12	34,2	36,5	24
BW2306-22DHF90	BW23.5193.0622	06	3/8"	M22X1.5	14	34,2	37,0	27
BW2308-24DHF90	BW23.5193.0824	08	1/2"	M24X1.5	16	41,0	43,0	30
BW2310-30DHF90	BW23.5193.1030	10	5/8"	M30X2.0	20	49,0	49,5	36
BW2312-30DHF90	BW23.5193.1230	12	3/4"	M30X2.0	20	60,5	58,0	36
BW2312-36DHF90	BW23.5193.1236	12	3/4"	M36X2.0	25	60,0	59,0	46
BW2316-36DHF90	BW23.5193.1636	16	1"	M36X2.0	25	75,0	70,0	46
BW2316-42DHF90	BW23.5193.1642	16	1"	M42X2.0	30	76,0	70,0	50
BW2320-52DHF90	BW23.5193.2052	20	1,1/4"	M52X2.0	38	87,0	87,0	60

MATERIAL: Carbon Steel

FINISH: Chromium-(VI) Free plating / ROHS compliant

Suitable to be used on medium and high pressure braided and spiral hoses:

FORZA UNO R1AT/1SN; FORZA UNO "SHARK SKIN" R1AT/1SN; FORZA UNO TROPIC R1AT/1SN; FORZA DUE R2AT/2SN; FORZA DUE "SHARK SKIN" R2AT/2SN; FORZA DUE TROPIC R2AT/2SN; BALPAC PREMIUM R16/2SC; BALPAC PREMIUM "SHARK SKIN" R16/2SC; BALPAC PREMIUM TROPIC R16/2SC; IMPACTUS 5K; IMPACTUS 6K; BALPAC 3000 R17/1SC; BALPAC 3000 "SHARK SKIN" R17/1SC; 2-MAX JACK; BALWASH 1W; BALWASH 2W; BALMASTER BESTFLEX R12; BALMASTER BESTFLEX 4SP; POWERSPIR BESTFLEX 4SH; POWERSPIR BESTFLEX R13 (3/4" & 1"); POWERSPIR BESTFLEX R15 (3/4" & 1")



Heavy 24° Metric Male - DHM

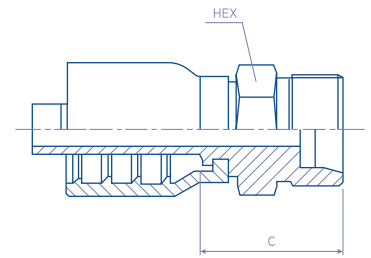

BW23.1100.
ISO 12151-2 / ISO 8434-1

REFERENCE	#	hose		thread	dimensions		
		dash	inch		d	C - Cut Off	HEX
BW2304-14DHM	BW23.1100.0414	04	1/4"	M14X1.5	6	26,7	17
BW2304-16DHM	BW23.1100.0416	04	1/4"	M16X1.5	8	26,7	17
BW2304-18DHM	BW23.1100.0418	04	1/4"	M18X1.5	10	27,7	19
BW2304-20DHM	BW23.1100.0420	04	1/4"	M20X1.5	12	29,2	22
BW2306-18DHM	BW23.1100.0618	06	3/8"	M18X1.5	10	25,7	19
BW2306-20DHM	BW23.1100.0620	06	3/8"	M20X1.5	12	27,2	22
BW2306-22DHM	BW23.1100.0622	06	3/8"	M22X1.5	14	29,7	24
BW2306-24DHM	BW23.1100.0624	06	3/8"	M24X1.5	16	31,2	27
BW2308-24DHM	BW23.1100.0824	08	1/2"	M24X1.5	16	33,0	27
BW2310-30DHM	BW23.1100.1030	10	5/8"	M30X2.0	20	38,0	32
BW2312-30DHM	BW23.1100.1230	12	3/4"	M30X2.0	20	37,3	32
BW2312-36DHM	BW23.1100.1236	12	3/4"	M36X2.0	25	42,3	41
BW2316-36DHM	BW23.1100.1636	16	1"	M36X2.0	25	42,2	41
BW2316-42DHM	BW23.1100.1642	16	1"	M42X2.0	30	45,7	46
BW2320-52DHM	BW23.1100.2052	20	1,1/4"	M52X2.0	38	50,0	55

MATERIAL: Carbon Steel

FINISH: Chromium-(VI) Free plating /
ROHS compliant

Suitable to be used on medium and high pressure braided and spiral hoses:

FORZA UNO R1AT/1SN; FORZA UNO "SHARK SKIN" R1AT/1SN; FORZA UNO TROPIC R1AT/1SN;
FORZA DUE R2AT/2SN; FORZA DUE "SHARK SKIN" R2AT/2SN; FORZA DUE TROPIC R2AT/2SN;
BALPAC PREMIUM R16/2SC; BALPAC PREMIUM "SHARK SKIN" R16/2SC; BALPAC PREMIUM
TROPIC R16/2SC; IMPACTUS 5K; IMPACTUS 6K; BALPAC 3000 R17/1SC; BALPAC 3000 "SHARK
SKIN" R17/1SC; 2-MAX JACK; BALWASH 1W; BALWASH 2W; BALMASTER BESTFLEX R12;
BALMASTER BESTFLEX 4SP; POWERSPIR BESTFLEX 4SH; POWERSPIR BESTFLEX R13 (3/4" &
1"); POWERSPIR BESTFLEX R15 (3/4" & 1")

JIS 30° Female Swivel - FX-KOMA

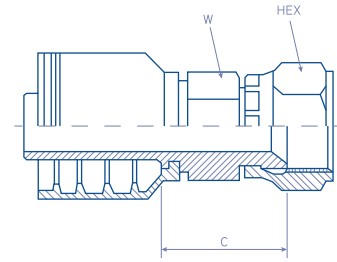

BW23.5911.

JIS B 8363

REFERENCE	#	hose		thread	dimensions		
		dash	inch		C - Cut Off	W	HEX
BW2304-14FX-KOMA	BW23.5911.0414	04	1/4"	M14X1.5	24,2	19	19
BW2306-16FX-KOMA	BW23.5911.0616	06	3/8"	M16X1.5	23,2	19	22
BW2306-18FX-KOMA	BW23.5911.0618	06	3/8"	M18X1.5	24,2	19	24
BW2306-20FX-KOMA	BW23.5911.0620	06	3/8"	M20X1.5	25,2	19	27
BW2308-22FX-KOMA	BW23.5911.0822	08	1/2"	M22X1.5	28,0	22	27
BW2310-24FX-KOMA	BW23.5911.1024	10	5/8"	M24X1.5	30,5	24	32
BW2312-30FX-KOMA	BW23.5911.1230	12	3/4"	M30X1.5	32,8	30	36
BW2312-33FX-KOMA	BW23.5911.1233	12	3/4"	M33X1.5	33,8	32	41
BW2312-36FX-KOMA	BW23.5911.1236	12	3/4"	M36X1.5	36,3	41	46
BW2316-33FX-KOMA	BW23.5911.1633	16	1"	M33X1.5	33,7	32	41
BW2316-36FX-KOMA	BW23.5911.1636	16	1"	M36X1.5	26,2	41	46
BW2320-36FX-KOMA	BW23.5911.2036	20	1.1/4"	M36X1.5	36,5	41	46
BW2324-42FX-KOMA	BW23.5911.2442	24	1.1/2"	M42X1.5	43,4	50	55

MATERIAL: Carbon Steel

FINISH: Chromium-(VI) Free plating / ROHS compliant

Suitable to be used on medium and high pressure braided and spiral hoses:

FORZA UNO R1AT/1SN; FORZA UNO "SHARK SKIN" R1AT/1SN; FORZA UNO TROPIC R1AT/1SN; FORZA DUE R2AT/2SN; FORZA DUE "SHARK SKIN" R2AT/2SN; FORZA DUE TROPIC R2AT/2SN; BALPAC PREMIUM R16/2SC; BALPAC PREMIUM "SHARK SKIN" R16/2SC; BALPAC PREMIUM TROPIC R16/2SC; IMPACTUS 5K; IMPACTUS 6K; BALPAC 3000 R17/1SC; BALPAC 3000 "SHARK SKIN" R17/1SC; 2-MAX JACK; BALWASH 1W; BALWASH 2W; BALMASTER BESTFLEX R12; BALMASTER BESTFLEX 4SP; POWERSPIR BESTFLEX 4SH; POWERSPIR BESTFLEX R13 (3/4" & 1"); POWERSPIR BESTFLEX R15 (3/4" & 1")



Female JIS 30° Swivel 90° Elbow - FX-KOMA90

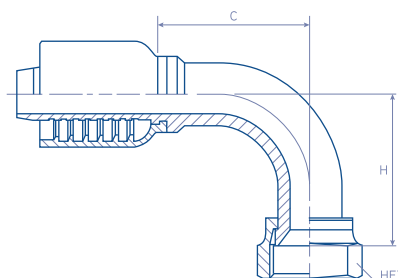

BW23.5991.

JIS B 8363

REFERENCE	#	hose		thread	dimensions		
		dash	inch		C - Cut Off	H	HEX
BW2304-14FX-KOMA90	BW23.5991.0414	04	1/4"	M14X1.5	25,0	28	19
BW2306-18FX-KOMA90	BW23.5991.0618	06	3/8"	M18X1.5	31,0	37	24
BW2308-22FX-KOMA90	BW23.5991.0822	08	1/2"	M22X1.5	41,0	48	27
BW2310-24FX-KOMA90	BW23.5991.1024	10	5/8"	M24X1.5	42,0	50	32
BW2312-30FX-KOMA90	BW23.5991.1230	12	3/4"	M30X1.5	48,5	57	36

MATERIAL: Carbon Steel

FINISH: Chromium-(VI) Free plating /
ROHS compliant

Suitable to be used on medium and high pressure braided and spiral hoses:

FORZA UNO R1AT/1SN; FORZA UNO "SHARK SKIN" R1AT/1SN; FORZA UNO TROPIC R1AT/1SN;
FORZA DUE R2AT/2SN; FORZA DUE "SHARK SKIN" R2AT/2SN; FORZA DUE TROPIC R2AT/2SN;
BALPAC PREMIUM R16/2SC; BALPAC PREMIUM "SHARK SKIN" R16/2SC; BALPAC PREMIUM
TROPIC R16/2SC; IMPACTUS 5K; IMPACTUS 6K; BALPAC 3000 R17/1SC; BALPAC 3000 "SHARK
SKIN" R17/1SC; 2-MAX JACK; BALWASH 1W; BALWASH 2W; BALMASTER BESTFLEX R12;
BALMASTER BESTFLEX 4SP; POWERSPIR BESTFLEX 4SH; POWERSPIR BESTFLEX R13 (3/4" &
1"); POWERSPIR BESTFLEX R15 (3/4" & 1")

JIS 30° Female Swivel - JIS

BW23.3712.

JIS B 8363

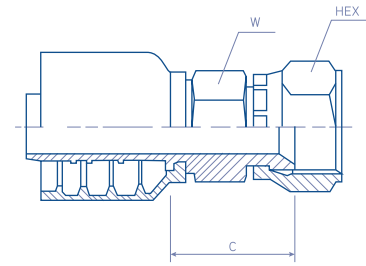

REFERENCE	#	hose		thread	dimensions		
		dash	inch		C - Cut Off	W	HEX
BW2304-04JIS	BW23.3712.0404	04	1/4"	1/4" - 19	23,0	19	19
BW2306-06JIS	BW23.3712.0606	06	3/8"	3/8" - 19	23,0	22	22
BW2308-08JIS	BW23.3712.0808	08	1/2"	1/2" - 14	27,7	27	27
BW2312-12JIS	BW23.3712.1212	12	3/4"	3/4" - 14	31,4	32	32
BW2316-16JIS	BW23.3712.1616	16	1"	1" - 11	32,0	41	41
BW2320-20JIS	BW23.3712.2020	20	1.1/4"	1.1/4" - 11	35,5	50	50

MATERIAL: Carbon Steel

FINISH: Chromium-(VI) Free plating / ROHS compliant

Suitable to be used on medium and high pressure braided and spiral hoses:

FORZA UNO R1AT/1SN; FORZA UNO "SHARK SKIN" R1AT/1SN; FORZA UNO TROPIC R1AT/1SN; FORZA DUE R2AT/2SN; FORZA DUE "SHARK SKIN" R2AT/2SN; FORZA DUE TROPIC R2AT/2SN; BALPAC PREMIUM R16/2SC; BALPAC PREMIUM "SHARK SKIN" R16/2SC; BALPAC PREMIUM TROPIC R16/2SC; IMPACTUS 5K; IMPACTUS 6K; BALPAC 3000 R17/1SC; BALPAC 3000 "SHARK SKIN" R17/1SC; 2-MAX JACK; BALWASH 1W; BALWASH 2W; BALMASTER BESTFLEX R12; BALMASTER BESTFLEX 4SP; POWERSPIR BESTFLEX 4SH; POWERSPIR BESTFLEX R13 (3/4" & 1"); POWERSPIR BESTFLEX R15 (3/4" & 1")



BSP 60° Swivel Female - BSPXF

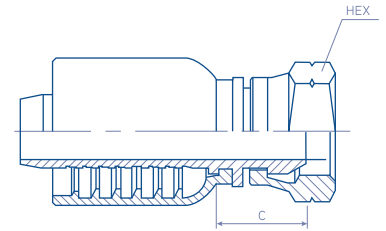

BW23.3012.

ISO 12151-6 / ISO 8434-6

REFERENCE	#	hose		thread	dimensions	
		dash	inch		C - Cut Off	HEX
BW2304-02BSPXF	BW23.3012.0402	04	1/4"	1/8"-28	17,7	14
BW2304-04BSPXF	BW23.3012.0404	04	1/4"	1/4"-19	19,9	19
BW2304-06BSPXF	BW23.3012.0406	04	1/4"	3/8"-19	20,7	22
BW2304-08BSPXF	BW23.3012.0408	04	1/4"	1/2"-14	22,7	27
BW2306-06BSPXF	BW23.3012.0606	06	3/8"	3/8"-19	19,5	22
BW2306-08BSPXF	BW23.3012.0608	06	3/8"	1/2"-14	20,7	27
BW2308-08BSPXF	BW23.3012.0808	08	1/2"	1/2"-14	22,7	27
BW2308-10BSPXF	BW23.3012.0810	08	1/2"	5/8"-14	23,0	30
BW2310-10BSPXF	BW23.3012.1010	10	5/8"	5/8"-14	25,0	30
BW2310-12BSPXF	BW23.3012.1012	10	5/8"	3/4"-14	25,5	32
BW2312-12BSPXF	BW23.3012.1212	12	3/4"	3/4"-14	24,9	32
BW2312-16BSPXF	BW23.3012.1216	12	3/4"	1"-11	26,8	38
BW2316-16BSPXF	BW23.3012.1616	16	1"	1"-11	26,8	38
BW2316-20BSPXF	BW23.3012.1620	16	1"	1 1/4"-11	29,2	50
BW2320-20BSPXF	BW23.3012.2020	20	1 1/4"	1 1/4"-11	29,5	50
BW2320-24BSPXF	BW23.3012.2024	20	1 1/4"	1 1/2"-11	31,0	55
BW2324-24BSPXF	BW23.3012.2424	24	1 1/2"	1 1/2"-11	33,4	55
BW2324-32BSPXF	BW23.3012.2432	24	1 1/2"	2"-11	35,4	70
BW2332-32BSPXF	BW23.3012.3232	32	2"	2"-11	36,6	70

MATERIAL: Carbon Steel

FINISH: Chromium-(VI) Free plating /
ROHS compliant

Suitable to be used on medium and high pressure braided and spiral hoses:

FORZA UNO R1AT/1SN; FORZA UNO "SHARK SKIN" R1AT/1SN; FORZA UNO TROPIC R1AT/1SN; FORZA DUE R2AT/2SN; FORZA DUE "SHARK SKIN" R2AT/2SN; FORZA DUE TROPIC R2AT/2SN; BALPAC PREMIUM R16/2SC; BALPAC PREMIUM "SHARK SKIN" R16/2SC; BALPAC PREMIUM TROPIC R16/2SC; IMPACTUS 5K; IMPACTUS 6K; BALPAC 3000 R17/1SC; BALPAC 3000 "SHARK SKIN" R17/1SC; 2-MAX JACK; BALWASH 1W; BALWASH 2W; BALMASTER BESTFLEX R12; BALMASTER BESTFLEX 4SP; POWERSPIR BESTFLEX 4SH; POWERSPIR BESTFLEX R13 (3/4" & 1"); POWERSPIR BESTFLEX R15 (3/4" & 1")

BSP 60° Swivel 45° Elbow Female - BSPXF45

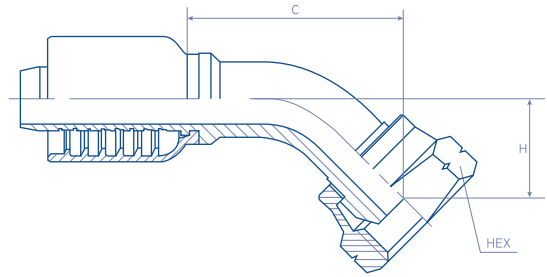

BW23.3042.

ISO 12151-6 / ISO 8434-6

REFERENCE	#	hose		thread	dimensions		
		dash	inch		C - Cut Off	H	HEX
BW2304-02BSPXF45	BW23.3042.0402	04	1/4"	1/8"-28	33,0	14,0	14
BW2304-04BSPXF45	BW23.3042.0404	04	1/4"	1/4"-19	41,1	15,0	19
BW2304-06BSPXF45	BW23.3042.0406	04	1/4"	3/8"-19	34,2	15,0	22
BW2306-06BSPXF45	BW23.3042.0606	06	3/8"	3/8"-19	40,0	17,5	22
BW2306-08BSPXF45	BW23.3042.0608	06	3/8"	1/2"-14	38,6	17,0	27
BW2308-08BSPXF45	BW23.3042.0808	08	1/2"	1/2"-14	46,0	19,0	27
BW2308-10BSPXF45	BW23.3042.0810	08	1/2"	5/8"-14	56,0	23,0	27
BW2310-10BSPXF45	BW23.3042.1010	10	5/8"	5/8"-14	60,5	23,3	27
BW2310-12BSPXF45	BW23.3042.1012	10	5/8"	3/4"-14	63,0	28,0	32
BW2312-12BSPXF45	BW23.3042.1212	12	3/4"	3/4"-14	67,8	29,0	32
BW2312-16BSPXF45	BW23.3042.1216	12	3/4"	1"-11	72,6	27,5	38
BW2316-16BSPXF45	BW23.3042.1616	16	1"	1"-11	83,7	33,8	38
BW2316-20BSPXF45	BW23.3042.1620	16	1"	1.1/4"-11	92,3	41,0	50
BW2320-20BSPXF45	BW23.3042.2020	20	1.1/4"	1.1/4"-11	97,0	40,0	50
BW2320-24BSPXF45	BW23.3042.2024	20	1.1/4"	1.1/2"-11	102,0	50,0	55
BW2324-24BSPXF45	BW23.3042.2424	24	1.1/2"	1.1/2"-11	119,0	50,0	55
BW2324-32BSPXF45	BW23.3042.2432	24	1.1/2"	2"-11	132,0	59,0	70
BW2332-32BSPXF45	BW23.3042.3232	32	2"	2"-11	149,8	70,0	70

MATERIAL: Carbon Steel

FINISH: Chromium-(VI) Free plating /
ROHS compliant

Suitable to be used on medium and high pressure braided and spiral hoses:

FORZA UNO R1AT/1SN; FORZA UNO "SHARK SKIN" R1AT/1SN; FORZA UNO TROPIC R1AT/1SN;
FORZA DUE R2AT/2SN; FORZA DUE "SHARK SKIN" R2AT/2SN; FORZA DUE TROPIC R2AT/2SN;
BALPAC PREMIUM R16/2SC; BALPAC PREMIUM "SHARK SKIN" R16/2SC; BALPAC PREMIUM
TROPIC R16/2SC; IMPACTUS 5K; IMPACTUS 6K; BALPAC 3000 R17/1SC; BALPAC 3000 "SHARK
SKIN" R17/1SC; 2-MAX JACK; BALWASH 1W; BALWASH 2W; BALMASTER BESTFLEX R12;
BALMASTER BESTFLEX 4SP; POWERSPIR BESTFLEX 4SH; POWERSPIR BESTFLEX R13 (3/4" &
1"); POWERSPIR BESTFLEX R15 (3/4" & 1")



BSP 60° Swivel 90° Elbow Female - BSPXF90

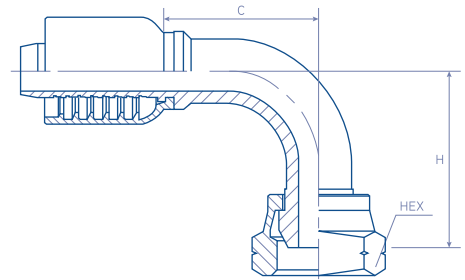

BW23.3092.

ISO 12151-6 / ISO 8434-6

REFERENCE	#	hose		thread	dimensions		
		dash	inch		C - Cut Off	H	HEX
BW2304-02BSPXF90	BW23.3092.0402	04	1/4"	1/8"-28	27,5	27,0	14
BW2304-04BSPXF90	BW23.3092.0404	04	1/4"	1/4"-19	27,6	28,0	19
BW2304-06BSPXF90	BW23.3092.0406	04	1/4"	3/8"-19	30,0	31,0	22
BW2306-06BSPXF90	BW23.3092.0606	06	3/8"	3/8"-19	34,2	31,7	22
BW2306-08BSPXF90	BW23.3092.0608	06	3/8"	1/2"-14	32,7	36,5	27
BW2308-08BSPXF90	BW23.3092.0808	08	1/2"	1/2"-14	41,0	40,0	27
BW2308-10BSPXF90	BW23.3092.0810	08	1/2"	5/8"-14	46,5	46,0	27
BW2310-10BSPXF90	BW23.3092.1010	10	5/8"	5/8"-14	54,0	50,0	27
BW2310-12BSPXF90	BW23.3092.1012	10	5/8"	3/4"-14	54,0	54,0	32
BW2312-12BSPXF90	BW23.3092.1212	12	3/4"	3/4"-14	56,0	58,0	32
BW2312-16BSPXF90	BW23.3092.1216	12	3/4"	1"-11	60,0	62,0	38
BW2316-16BSPXF90	BW23.3092.1616	16	1"	1"-11	71,5	71,0	38
BW2316-20BSPXF90	BW23.3092.1620	16	1"	1 1/4"-11	79,5	78,0	50
BW2320-20BSPXF90	BW23.3092.2020	20	1 1/4"	1 1/4"-11	86,5	83,0	50
BW2320-24BSPXF90	BW23.3092.2024	20	1 1/4"	1 1/2"-11	91,5	92,0	55
BW2324-24BSPXF90	BW23.3092.2424	24	1 1/2"	1 1/2"-11	110,0	104,0	55
BW2324-32BSPXF90	BW23.3092.2432	24	1 1/2"	2"-11	110,0	110,0	70
BW2332-32BSPXF90	BW23.3092.3232	32	2"	2"-11	130,0	130,0	70

MATERIAL: Carbon Steel

FINISH: Chromium-(VI) Free plating /
ROHS compliant

Suitable to be used on medium and high pressure braided and spiral hoses:

FORZA UNO R1AT/1SN; FORZA UNO "SHARK SKIN" R1AT/1SN; FORZA UNO TROPIC R1AT/1SN; FORZA DUE R2AT/2SN; FORZA DUE "SHARK SKIN" R2AT/2SN; FORZA DUE TROPIC R2AT/2SN; BALPAC PREMIUM R16/2SC; BALPAC PREMIUM "SHARK SKIN" R16/2SC; BALPAC PREMIUM TROPIC R16/2SC; IMPACTUS 5K; IMPACTUS 6K; BALPAC 3000 R17/1SC; BALPAC 3000 "SHARK SKIN" R17/1SC; 2-MAX JACK; BALWASH 1W; BALWASH 2W; BALMASTER BESTFLEX R12; BALMASTER BESTFLEX 4SP; POWERSPIR BESTFLEX 4SH; POWERSPIR BESTFLEX R13 (3/4" & 1"); POWERSPIR BESTFLEX R15 (3/4" & 1")

BSP 60° Male - BSPM

BW23.0100.

ISO 12151-6 / ISO 8434-6

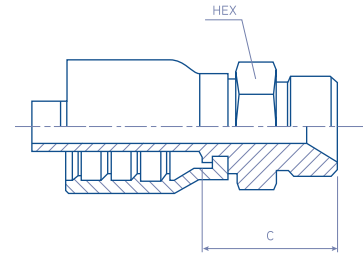

REFERENCE	#	hose		thread	dimensions	
		dash	inch		C - Cut Off	HEX
BW2304-02BSPM	BW23.0100.0402	04	1/4"	1/8"-28	24,2	14
BW2304-04BSPM	BW23.0100.0404	04	1/4"	1/4"-19	28,2	19
BW2304-06BSPM	BW23.0100.0406	04	1/4"	3/8"-19	30,7	22
BW2304-08BSPM	BW23.0100.0408	04	1/4"	1/2"-14	35,2	27
BW2306-04BSPM	BW23.0100.0604	06	3/8"	1/4"-19	26,2	19
BW2306-06BSPM	BW23.0100.0606	06	3/8"	3/8"-19	28,7	22
BW2306-08BSPM	BW23.0100.0608	06	3/8"	1/2"-14	33,2	27
BW2308-06BSPM	BW23.0100.0806	08	1/2"	3/8"-19	30,5	22
BW2308-08BSPM	BW23.0100.0808	08	1/2"	1/2"-14	34,5	27
BW2308-10BSPM	BW23.0100.0810	08	1/2"	5/8"-14	37,5	30
BW2308-12BSPM	BW23.0100.0812	08	1/2"	3/4"-14	40,5	32
BW2310-08BSPM	BW23.0100.1008	10	5/8"	1/2"-14	36,5	27
BW2310-10BSPM	BW23.0100.1010	10	5/8"	5/8"-14	38,0	30
BW2310-12BSPM	BW23.0100.1012	10	5/8"	3/4"-14	41,5	32
BW2312-08BSPM	BW23.0100.1208	12	3/4"	1/2"-14	35,8	27
BW2312-12BSPM	BW23.0100.1212	12	3/4"	3/4"-14	40,3	32
BW2312-16BSPM	BW23.0100.1216	12	3/4"	1"-11	45,3	41
BW2316-16BSPM	BW23.0100.1616	16	1"	1"-11	45,2	41
BW2316-20BSPM	BW23.0100.1620	16	1"	1.1/4"-11	48,2	50
BW2320-20BSPM	BW23.0100.2020	20	1.1/4"	1.1/4"-11	48,5	50
BW2320-24BSPM	BW23.0100.2024	20	1.1/4"	1.1/2"-11	51,0	55
BW2324-24BSPM	BW23.0100.2424	24	1.1/2"	1.1/2"-11	53,4	55
BW2324-32BSPM	BW23.0100.2432	24	1.1/2"	2"-11	58,9	70
BW2332-32BSPM	BW23.0100.3232	32	2"	2"-11	60,1	70

MATERIAL: Carbon Steel

FINISH: Chromium-(VI) Free plating /
ROHS compliant

Suitable to be used on medium and high pressure braided and spiral hoses:

FORZA UNO R1AT/1SN; FORZA UNO "SHARK SKIN" R1AT/1SN; FORZA UNO TROPIC R1AT/1SN; FORZA DUE R2AT/2SN; FORZA DUE "SHARK SKIN" R2AT/2SN; FORZA DUE TROPIC R2AT/2SN; BALPAC PREMIUM R16/2SC; BALPAC PREMIUM "SHARK SKIN" R16/2SC; BALPAC PREMIUM TROPIC R16/2SC; IMPACTUS 5K; IMPACTUS 6K; BALPAC 3000 R17/1SC; BALPAC 3000 "SHARK SKIN" R17/1SC; 2-MAX JACK; BALWASH 1W; BALWASH 2W; BALMASTER BESTFLEX R12; BALMASTER BESTFLEX 4SP; POWERSPIR BESTFLEX 4SH; POWERSPIR BESTFLEX R13 (3/4" & 1"); POWERSPIR BESTFLEX R15 (3/4" & 1")

BW26 – 6 Spiral Series One Piece Fitting

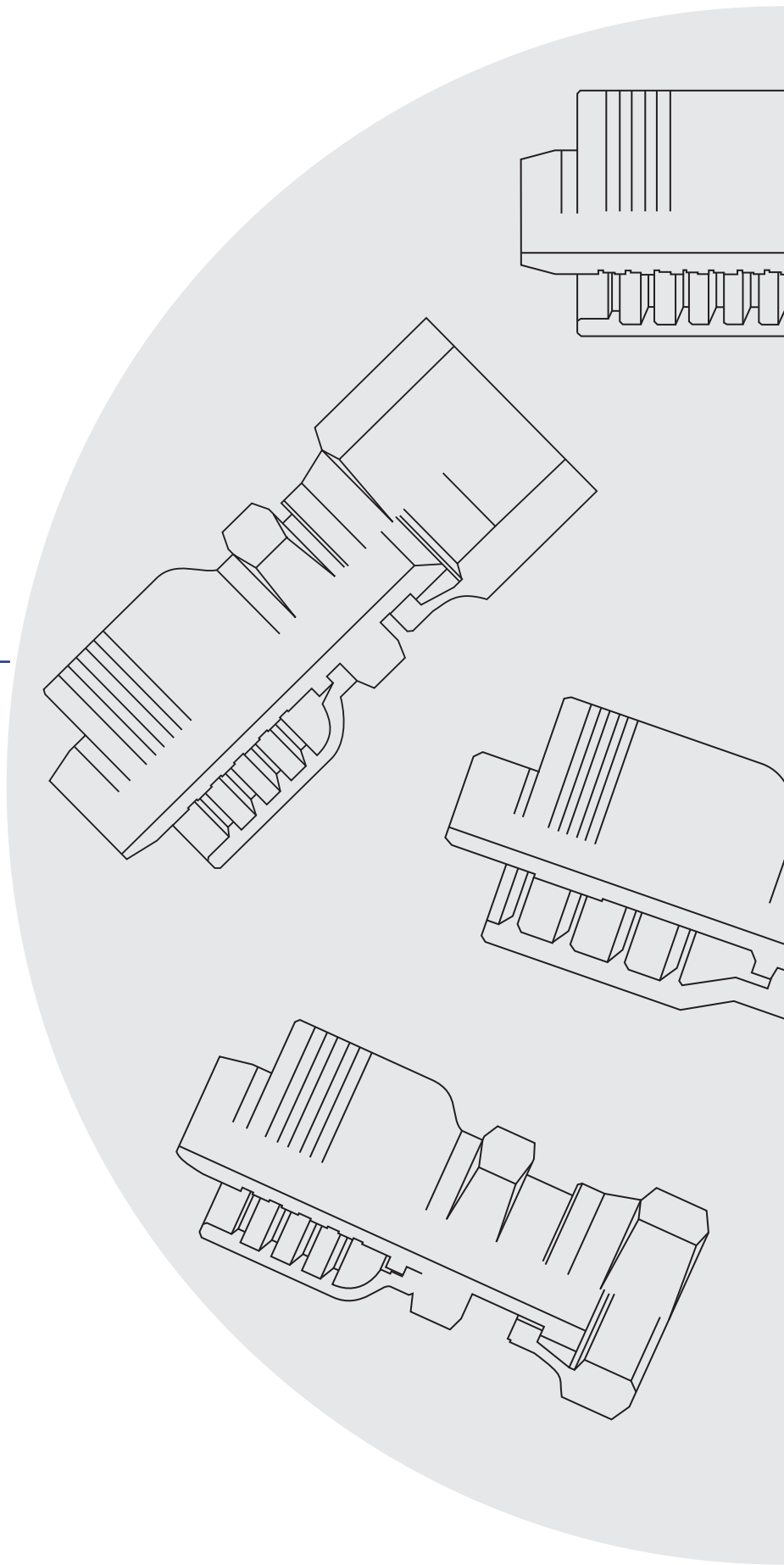

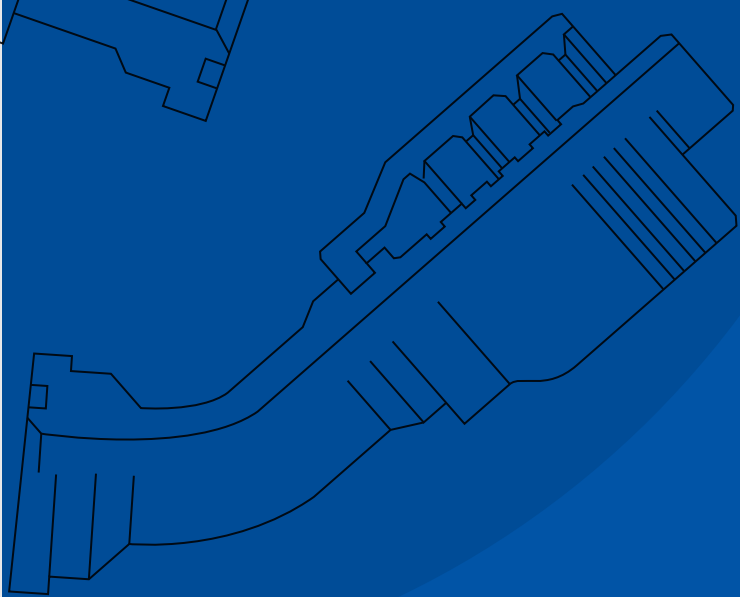
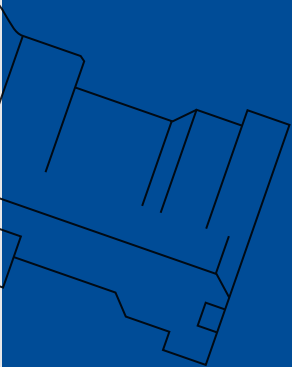
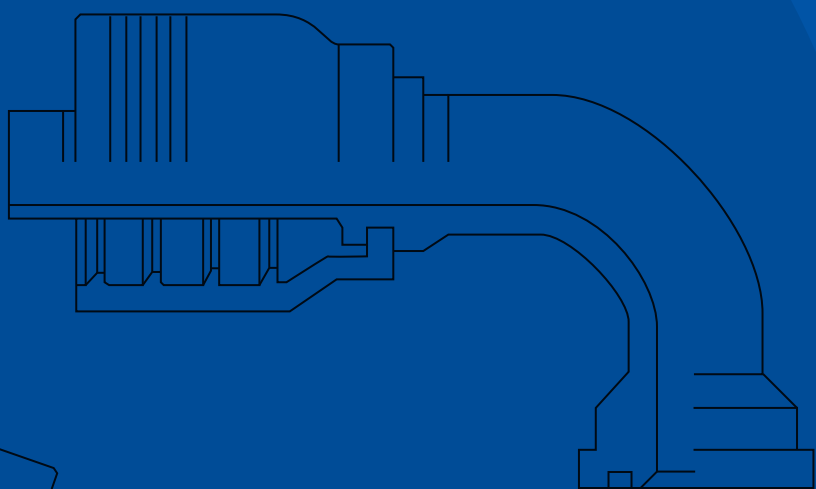
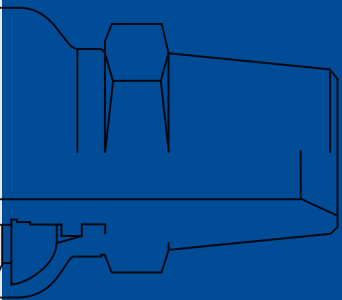

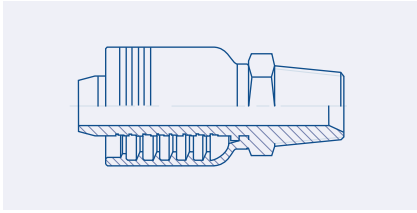

Male NPTF Pipe Rigid - MP

BW26.0400.

pag. 71

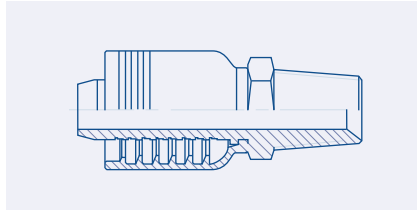

**Male API Pipe - MPAPI
(long Nose)**

BW26.0440.

pag. 71

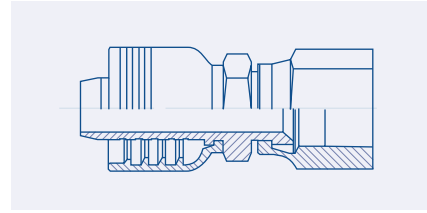

Female JIC 37° Swivel - FJ

BW26.4H12.

pag. 72

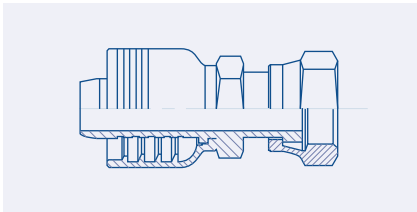

Female ORFS Swivel - OFT

BW26.44H4.

pag. 72

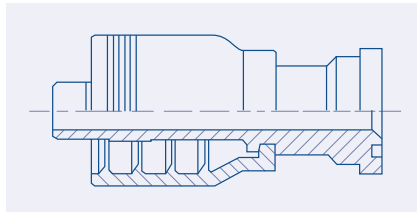

**Straight SAE 6000 PSI
Code 62 Flange - PH**

BW26.7016.

pag. 73

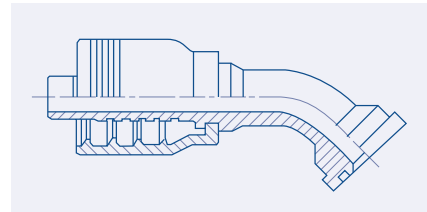

**45° Elbow SAE 6000 PSI
Code 62 Flange - PH45**

BW26.7046.

pag. 73

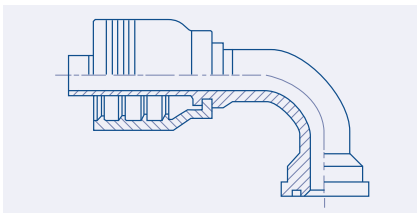

**90° Elbow SAE 6000 PSI
Code 62 Flange - PH90**

BW26.7096.

pag. 74

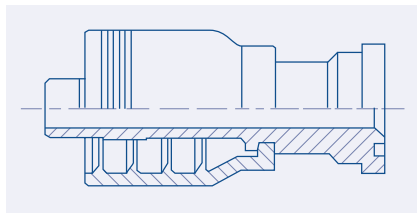

**Straight SuperCAT Flange -
SC**

BW26.7116.

pag. 74

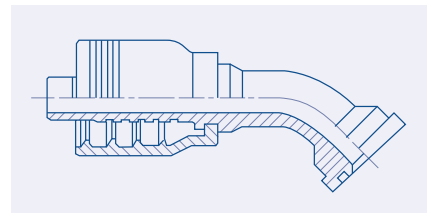

**45° Elbow SuperCAT Flange
- SC45**

BW26.7146.

pag. 75

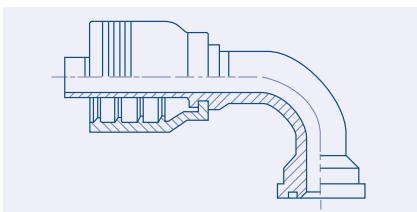

**90° Elbow SuperCAT Flange
- SC90**

BW26.7196.

pag. 75



Male NPTF Pipe Rigid - MP

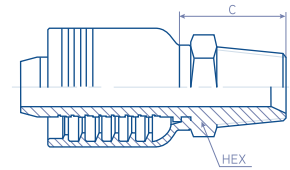

BW26.0400.
SAE J516 / SAE J514

REFERENCE	#	hose		thread	dimensions	
		dash	inch		C - Cut Off	HEX
BW2620-20MP	BW26.0400.2020	20	1.1/4"	1.1/4" - 11	53.4	46
BW2624-24MP	BW26.0400.2424	24	1.1/2"	1.1/2" - 11	58.4	50
BW2632-32MP	BW26.0400.3232	32	2"	2" - 11	67.3	65

MATERIAL: Carbon Steel

FINISH: Chromium-(VI) Free plating / ROHS compliant

Suitable to be used on 6 spiral hoses:

POWERSPIR BESTFLEX R13 (1.1/4" & 1.1/2" & 2"); POWERSPIR BESTFLEX R15 (1.1/4" & 1.1/2" & 2")

Male API Pipe – MPAPI (Long Nose)

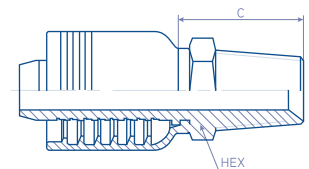

BW26.0440.

REFERENCE	#	hose		thread	dimensions	
		dash	inch		C - Cut Off	HEX
BW2632-32MPAPI	BW26.0440.3232	32	2"	2" - 11	107.8	50

MATERIAL: Carbon Steel

FINISH: Chromium-(VI) Free plating / ROHS compliant

Suitable to be used on 6 spiral hoses:

POWERSPIR BESTFLEX R13 (2"); POWERSPIR BESTFLEX R15 (2")

Female JIC 37° Swivel - FJ

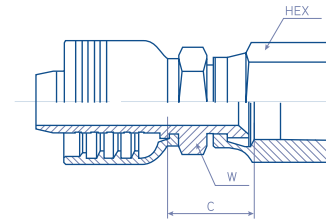

BW26.4H12.

ISO 12151-5 / ISO 8434-2 / SAE J516 / SAE J514

REFERENCE	#	hose		thread	dimensions		
		dash	inch		C - Cut Off	W	HEX
BW2620-20FJ	BW26.4H12.2020	20	1.1/4"	1.5/8"-12	55.0	41	50
BW2624-24FJ	BW26.4H12.2424	24	1.1/2"	1.7/8"-12	70.0	50	57
BW2632-32FJ	BW26.4H12.3232	32	2"	2.1/2"-12	83.8	65	75

MATERIAL: Carbon Steel

FINISH: Chromium-(VI) Free plating / ROHS compliant

Suitable to be used on 6 spiral hoses:

POWERSPIR BESTFLEX R13 (1.1/4" & 1.1/2" & 2"); POWERSPIR BESTFLEX R15 (1.1/4" & 1.1/2" & 2")

Female ORFS Swivel - OFT

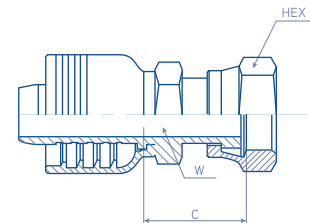

BW26.44H4.

ISO 12151-1 / ISO 8434-3 / SAE J1453

REFERENCE	#	hose		thread	dimensions		
		dash	inch		C - Cut Off	W	HEX
BW2620-20OFT	BW26.44H4.2020	20	1.1/4"	1.11/16"-12	78.5	41	50
BW2624-24OFT	BW26.44H4.2424	24	1.1/2"	2"-12	88.1	50	60

MATERIAL: Carbon Steel

FINISH: Chromium-(VI) Free plating / ROHS compliant

Suitable to be used on 6 spiral hoses:

POWERSPIR BESTFLEX R13 (2"); POWERSPIR BESTFLEX R15 (2")



Straight SAE 6000 PSI Code 62 Flange - PH

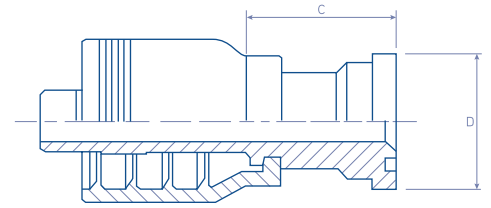

BW26.7016.

SAE J516 (CODE 62) / SAE J518 / ISO 12151-3

REFERENCE	#	hose		flange size	dimensions	
		dash	inch		C - Cut Off	D
BW2620-20PH	BW26.7016.2020	20	1.1/4"	1.1/4"	74	54
BW2620-24PH	BW26.7016.2024	20	1.1/4"	1.1/2"	73	63,5
BW2624-24PH	BW26.7016.2424	24	1.1/2"	1.1/2"	75	63,5
BW2624-32PH	BW26.7016.2432	24	1.1/2"	2"	76	79,4
BW2632-32PH	BW26.7016.3232	32	2"	2"	89	79,4

MATERIAL: Carbon Steel

FINISH: Chromium-(VI) Free plating / ROHS compliant

Suitable to be used on 6 spiral hoses:

POWERSPIR BESTFLEX R13 (1.1/4" & 1.1/2" & 2"); POWERSPIR BESTFLEX R15 (1.1/4" & 1.1/2" & 2")

45° Elbow SAE 6000 PSI Code 62 Flange - PH45

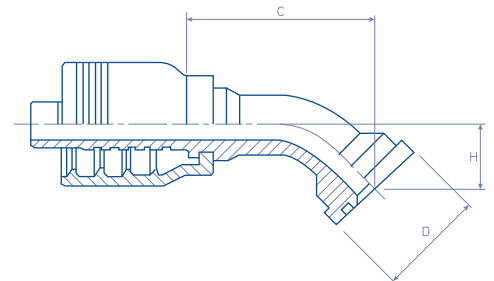

BW26.7046.

SAE J516 (CODE 62) / SAE J518 / ISO 12151-3

REFERENCE	#	hose		flange size	dimensions		
		dash	inch		C - Cut Off	H	D
BW2620-20PH45	BW26.7046.2020	20	1.1/4"	1.1/4"	118	43	54
BW2620-24PH45	BW26.7046.2024	20	1.1/4"	1.1/2"	120	48	63,5
BW2624-24PH45	BW26.7046.2424	24	1.1/2"	1.1/2"	152	48	63,5
BW2624-32PH45	BW26.7046.2432	24	1.1/2"	2"	148	57	79,4
BW2632-32PH45	BW26.7046.3232	32	2"	2"	170	63	79,4

MATERIAL: Carbon Steel

FINISH: Chromium-(VI) Free plating / ROHS compliant

VERSIONS: Other elbow angle configuration upon demand (Example: 22°)

Suitable to be used on 6 spiral hoses:

POWERSPIR BESTFLEX R13 (1.1/4" & 1.1/2" & 2"); POWERSPIR BESTFLEX R15 (1.1/4" & 1.1/2" & 2")

90° Elbow SAE 6000 PSI Code 62 Flange - PH90

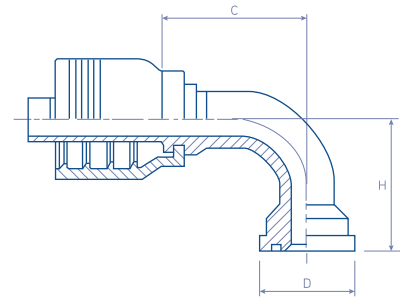

BW26.7096.

SAE J516 (CODE 62) / SAE J518 / ISO 12151-3

REFERENCE	#	hose		flange size	dimensions		
		dash	inch		C - Cut Off	H	D
BW2620-20PH90	BW26.7096.2020	20	1.1/4"	1.1/4"	102	86	54
BW2620-24PH90	BW26.7096.2024	20	1.1/4"	1.1/2"	104	98	63,5
BW2624-24PH90	BW26.7096.2424	24	1.1/2"	1.1/2"	124	100	63,5
BW2624-32PH90	BW26.7096.2432	24	1.1/2"	2"	129	119	79,4
BW2632-32PH90	BW26.7096.3232	32	2"	2"	162	135	79,4

MATERIAL: Carbon Steel

FINISH: Chromium-(VI) Free plating / ROHS compliant

VERSIONS: Long drop upon demand

Suitable to be used on 6 spiral hoses:

POWERSPIR BESTFLEX R13 (1.1/4" & 1.1/2" & 2"); POWERSPIR BESTFLEX R15 (1.1/4" & 1.1/2" & 2")

Straight SuperCAT Flange - SC

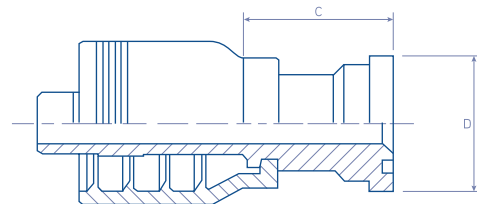

BW26.7116.

SAE J516 (CODE 62) / SAE J518 / ISO 12151-3

REFERENCE	#	hose		flange size	dimensions	
		dash	inch		C - Cut Off	D
BW2620-20SC	BW26.7116.2020	20	1.1/4"	1.1/4"	75	54
BW2620-24SC	BW26.7116.2024	20	1.1/4"	1.1/2"	82	63,5
BW2624-24SC	BW26.7116.2424	24	1.1/2"	1.1/2"	82	63,5
BW2624-32SC	BW26.7116.2432	24	1.1/2"	2"	95	79,4
BW2632-32SC	BW26.7116.3232	32	2"	2"	105	79,4

MATERIAL: Carbon Steel

FINISH: Chromium-(VI) Free plating / ROHS compliant

Suitable to be used on 6 spiral hoses:

POWERSPIR BESTFLEX R13 (1.1/4" & 1.1/2" & 2"); POWERSPIR BESTFLEX R15 (1.1/4" & 1.1/2" & 2")



45° Elbow SuperCAT Flange - SC45

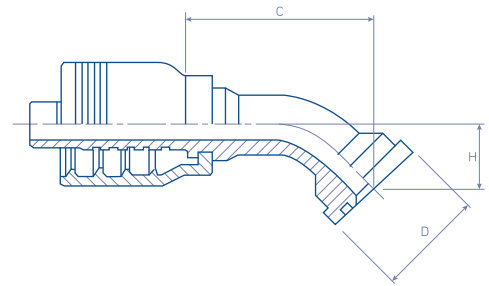

BW26.7146.

SAE J516 (CODE 62) / SAE J518 / ISO 12151-3

REFERENCE	#	hose		flange size	dimensions		
		dash	inch		C - Cut Off	H	D
BW2620-20SC45	BW26.7146.2020	20	1.1/4"	1.1/4"	115	46	54
BW2620-24SC45	BW26.7146.2024	20	1.1/4"	1.1/2"	118	49	63,5
BW2624-24SC45	BW26.7146.2424	24	1.1/2"	1.1/2"	140	49	63,5
BW2624-32SC45	BW26.7146.2432	24	1.1/2"	2"	165	60	79,4
BW2632-32SC45	BW26.7146.3232	32	2"	2"	174	65	79,4

MATERIAL: Carbon Steel

FINISH: Chromium-(VI) Free plating / ROHS compliant

VERSIONS: Other elbow angle configuration upon demand (Example: 22°)

Suitable to be used on 6 spiral hoses:

POWERSPIR BESTFLEX R13 (1.1/4" & 1.1/2" & 2"); POWERSPIR BESTFLEX R15 (1.1/4" & 1.1/2" & 2")

90° Elbow SuperCAT Flange - SC90

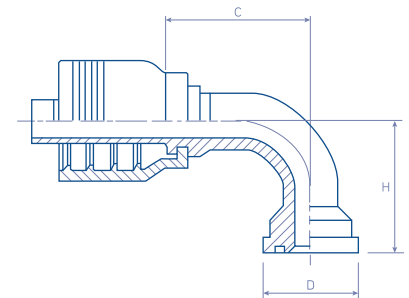

BW26.7196.

SAE J516 (CODE 62) / SAE J518 / ISO 12151-3

REFERENCE	#	hose		flange size	dimensions		
		dash	inch		C - Cut Off	H	D
BW2620-20SC90	BW26.7196.2020	20	1.1/4"	1.1/4"	105	90	54
BW2620-24SC90	BW26.7196.2024	20	1.1/4"	1.1/2"	105	100	63,5
BW2624-24SC90	BW26.7196.2424	24	1.1/2"	1.1/2"	120	106	63,5
BW2624-32SC90	BW26.7196.2432	24	1.1/2"	2"	120	122	79,4
BW2632-32SC90	BW26.7196.3232	32	2"	2"	156	135	79,4

MATERIAL: Carbon Steel

FINISH: Chromium-(VI) Free plating / ROHS compliant

VERSIONS: Long drop upon demand

Suitable to be used on 6 spiral hoses:

POWERSPIR BESTFLEX R13 (1.1/4" & 1.1/2" & 2"); POWERSPIR BESTFLEX R15 (1.1/4" & 1.1/2" & 2")

PRODUCTS LIMITED WARRANTY

The products sold by Balflex® are warranted to our customers to be free from defects in material and workmanship when shipment at Balflex® warehouses takes place.

All warranty claims shall be made present in writing to Balflex®. Balflex® liability hereunder is limited to the purchase price of the merchandise proving to be defective or, at balflex sole discretion, to the replacement of such merchandise upon its authorized return to Balflex®.

This warranty is in lieu of and excludes all other warranties, or conditions expressed, implied, statutory or otherwise created under applicable law including, but not limited to the warranty of merchantability and the warranty of fitness for a particular purpose.

In addition, this warranty shall not apply and will be null and void to any products or portions thereof that have been subject to abuse, misuse, improper installation, maintenance or operation, electrical failure or abnormal conditions and to products that have been tampered with, altered, modified, repaired, reworked by anyone not approved by balflex or used in any other manner inconsistent with any Balflex® instructions or specifications. Balflex® disclaims any liability for any hose assemblies which have not been produced with in conformance with Balflex® assembly recommendations and parts.

In no event shall balflex have any liability whatsoever to any person, including without limitation, any immediate buyer, purchaser or other third party, for any special, punitive, incidental or consequential damages, including without limitation, profit loss or customer loss, loss or damage to physical property of customer or any other person and loss of anticipated revenue, profits, goodwill, savings or other economic loss of customer or any other person.

Specification subject to change without prior notice.
Errors and omission excluded.



U.S.A. and Canada

6000 South Loop East Freeway
Houston, Tx 77033
United States of America
Tel: (1) 713-928-6064
Email: sales@balflex.com
www.balflexusa.com

Europe Headquarters

R. Bouça dos Estilhadouros, 226/254
4445-044 Alfena, Portugal
Tel: (351) 229 698 160
Email: balflex@balflex.com
www.balflex.com

Germany

Franckensteinstraße 8
77749 Hohberg
Tel: (49) 07808 4318857
Email: info@2bhydraulik.de
www.balflex.com

South America

R. Padre Cesari Lelli, 1014
Rodovia BR-116
CEP 83420-000 Quatro Barras/PR
Brasil
Tel: (55) 41 3671 3450
Email: comercial@balflex.com.br
www.balflex.com

An ISO 9001:2015 Company:



Cofinanciado por:



UNIKO EUROPEIA
Fundo Europeu
de Desenvolvimento Regional

