

Balflex[®]



**BF21 -
MULTI CRIMP
SERIES ONE PIECE,
NO SKIVE HYDRAULIC
FITTINGS CATALOG
2022**

European Technology

*Established since 1963, **Balflex**[®] is a European international group of companies dedicated to the design, production, assembly and distribution of all types of high-tech products for conduction of fluids, measuring of pressure and power transmission at very high quality level.*

*58 years of know-how and expertise in this field, makes **Balflex**[®] the first choice for the mining, agriculture, off-shore and construction industries.*

*Today the **Balflex**[®] Group covers worldwide users through our own company's production facilities, branches and net of certified distributors.*

Balflex[®] valorizes the inside meaning of the words we use: **Excellence** the quality of being outstanding; **Innovation** the action or process of innovating; **Partnership** cooperation relationship between two or more people, having in mind a common goal; **Tradition** way of thinking or acting, inherited from previous generations.

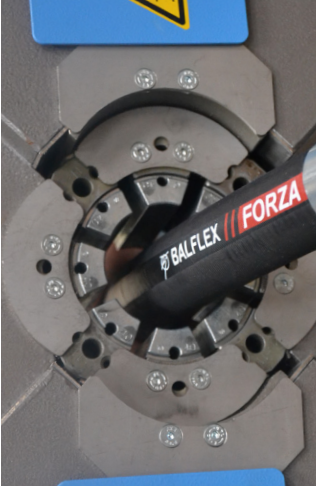
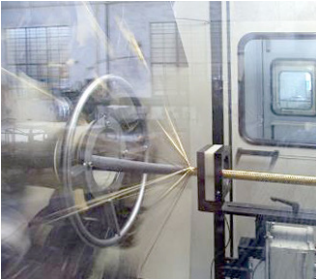



Quality

Quality is very important for us. We have fully equipped, modern laboratories and equipment, employing the industries most experienced personnel.

Balflex® has earned various certifications for our Management Systems and Products. This reliable and consistent approach has allowed us to achieve our ISO 9001:2015 certification. At Balflex® quality and service always comes first. We are dedicated to continue the development of new products with a strong emphasis on quality.

Member of:



Certified by:



Hose Fittings Pressure Ratings

For each type of fitting there is a maximum working pressure recommended in table below. Whenever information is not available, contact the manufacturer.

Inch Fittings (size)														
Maximum Working pressure (MPa/psi) – safety factor 4:1														
Description	Part Number	-2	-3	-4	-5	-6	-8	-10	-12	-16	-20	-24	-32	
NPTF Male	XX.0400 XX.0410 XX.0490	34.5 5000		27.6 4000		20.7 3000	20.7 3000			17.2 2500	13.8 2000	7.9 1150	6.9 1000	6.9 1000
BSP Male	XX.0100	42.0 6090		45.0 6525		40.0 5800	40.0 5800	40.0 5800	38.0 5510	34.5 5003	24.0 3480	21.0 3045	17.2 2494	
BSP Swivel Female	XX.3012 XX.3042 XX.3092	42.0 6090		45.0 6525		40.0 5800	40.0 5800	40.0 5800	38.0 5510	34.5 5003	24.0 3480	21.0 3045	17.2 2494	
BSP Swivel Female with O-ring	XX.3112 XX.3142 XX.3192			45.0 6525		40.0 5800	40.0 5800	40.0 5800	38.0 5510	34.5 5003	24.0 3480	21.0 3045	17.2 2494	
JIC 37° Male	XX.2000			35.0 5075	35.0 5075	35.0 5075	31.0 4495	24.0 3480	24.0 3480	21.0 3045	17.0 2465	14.0 2030	10.5 1523	
JIC 37° Swivel Female	XX.4012 XX.4042 XX.4092 XX.4H12			35.0 5075	35.0 5075	35.0 5075	31.0 4495	24.0 3480	24.0 3480	21.0 3045	17.0 2465	14.0 2030	10.5 1523	
Flange 3000 PSI	XX.7013 XX.7043 XX.7093						34.5 5000	34.5 5000	34.5 5000	34.5 5000	27.6 4000	20.7 3000	17.2 2500	
Flange 6000 PSI	XX.7016 XX.7046 XX.7096						41.4 6000	41.4 6000		41.4 6000	41.4 6000	41.4 6000	41.4 6000	
ORFS Male	XX.4000			63.0 9135		63.0 9135	63.0 9135	40.0 5800	40.0 5800	40.0 5800	25.0 3625	25.0 3625		
ORFS Female	XX.4414 XX.4444 XX.4494 XX.44H4			63.0 9135		63.0 9135	63.0 9135	40.0 5800	40.0 5800	40.0 5800	25.0 3625	25.0 3625		

The Working Pressure of the hose assembly shall be the lower of the pressures given for its sizes in the fittings standards and in the the relevant hose specification.

With our thick Zinc coating, Cr-VI free zinc plating process, a high corrosion resistance on all our carbon steel products is achieved, in compliance with EU and USA regulation, as well as with all relevant fitting standards, such as SAE J516 and DIN EN ISO 12151.

Due to exclusion of hexavalent chromium, we assure an environment friendly final product, without compromising the corrosion resistance.

Our zinc-plating when tested according to EN ISO 9227 guarantees minimum 240 hours, before appearance of corrosion.

(The presented values are measured before crimping operation)



Metric Tube (mm) – Light Serie "L"											
Maximum Working pressure (MPa/psi) – safety factor 4:1											
Description	Part Number	6	8	10	12	15	18	22	28	35	42
Metric Male	XX.1000	25.0 3625	25.0 3625	25.0 3625	25.0 3625	25.0 3625	16.0 2320	16.0 2320	10.0 1450	10.0 1450	10.0 1450
Metric Swivel Female with O-ring	XX.5013 XX.5043 XX.5093	25.0 3625	25.0 3625	25.0 3625	25.0 3625	25.0 3625	16.0 2320	16.0 2320	10.0 1450	10.0 1450	10.0 1450

Metric Tube (mm) – Heavy Serie "S"											
Maximum Working pressure (MPa/psi) – safety factor 4:1											
Description	Part Number	6	8	10	12	14	16	20	25	30	38
Metric Male	XX.1100	63.0 9135	63.0 9135	63.0 9135	63.0 9135	63.0 9135	40.0 5800	40.0 5800	40.0 5800	25.0 3625	25.0 3625
Metric Swivel Female with O-ring	XX.5113 XX.5143 XX.5193	63.0 9135	63.0 9135	63.0 9135	63.0 9135	63.0 9135	40.0 5800	40.0 5800	40.0 5800	25.0 3625	25.0 3625

The Working Pressure of the hose assembly shall be the lower of the pressures given for its sizes in the fittings standards and in the the relevant hose specification.

With our thick Zinc coating, Cr-VI free zinc plating process, a high corrosion resistance on all our carbon steel products is achieved, in compliance with EU and USA regulation, as well as with all relevant fitting standards, such as SAE J516 and DIN EN ISO 12151.

Due to exclusion of hexavalent chromium, we assure an environment friendly final product, without compromising the corrosion resistance.

Our zinc-plating when tested according to EN ISO 9227 guarantees minimum 240 hours, before appearance of corrosion.

(The presented values are measured before crimping operation)

The Correct Method to Fit Female Swivel Ends

To ensure a leakproof seal between swivel female hose ends shown in this catalogue and the appropriate adaptors it is necessary to follow the procedure below which is different from hydraulic tube assembly (This instruction is not valid for ORFS fittings).

Metal-to-metal seal

Screw the nut up hand tight and then with a spanner for one further 1/4 turn only.

Soft seal by O-ring

Screw the nut up hand tight and then with a spanner for one further 1/4 turn only.

Ensure that in all cases the hose is correctly aligned before tightening the nut onto the corresponding adaptor.

Spanner Torque Values

Metric swivel female			
Thread Metric	Tube O.D.	Nm	
		nominal	min. - max.
M 12x1,5	06L	16	15 - 17
M 14x1,5	08L	16	15 - 17
M 16x1,5	10L	26	25 - 28
M 18x1,5	12L	37	35 - 39
M 22x1,5	15L	47	45 - 50
M 26x1,5	18L	89	85 - 94
M 30x2	22L	116	110 - 121
M 36x2	28L	137	130 - 143
M 45x2	35L	226	215 - 237
M 52x2	42L	347	330 - 363
M 14x1,5	06S	26	25 - 28
M 16x1,5	08S	42	40 - 44
M 18x1,5	10S	53	50 - 55
M 20x1,5	12S	63	60 - 66
M 22x1,2	14S	79	75 - 83
M 24x1,5	16S	84	80 - 88
M 30x2	20S	126	120 - 132
M 36x2	25S	179	170 - 187
M 42x2	30S	263	250 - 275
M 52x2	38S	368	350 - 385

BSP swivel female			
Thread BSPP	Size	Nm	
		style A	style B
G1/8	-2	-	10
G1/4	-4	20	20
G3/8	-6	35	35
G1/2	-8	50	60
G5/8	-10	60	70
G3/4	-12	85	115
G1	-16	115	140
G1.1/4	-20	190	210
G1.1/2	-24	240	290
G2	-32	300	400



JIC 37° Swivel Female		
Thread UNF	Size	Nm +10% -0%
7/16-20	-4	15
1/2-20	-5	19
9/16-18	-6	24
3/4-16	-8	49
7/8-14	-10	77
1.1/16-12	-12	107
1.5/16-12	-16	147
1.5/8-12	-20	172
1.7/8-12	-24	215
2.1/2-12	-32	332

ORFS Swivel Female		
Thread UNF	Size	Nm +10% -0%
9/16-18	-4	25
11/16-18	-6	40
13/16-16	-8	55
1-14	-10	60
1.3/16-12	-12	90
1.5/16-12	-14	115
1.7/16-12	-16	125
1.11/16-12	-20	170
2-12	-24	200

The torque values for other materials are as follows:

- **Brass fittings and adapters**
65% of the torque value for steel.
- **Stainless steel**
use high side of the torque range for steel.
threads to be lubricated for these materials.
- **Dissimilar metals**
use torque value designated for the lower of the two materials.
- **All fittings are dry except as noted above.**

Note

Values given in tables are typical to achieve the recommended assembly methods when fitting material is steel zinc plated. For other materials different values will be applicable.

Quick identification of hydraulic connectors

DIN 24° light (L) and heavy series (S) with O-ring

The male has a 24° sealing angle cone seat with straight metric threads.
The female has a 24° convex cone with O-ring and a swivel straight metric threaded nut.

Standard: ISO 12151-2, ISO 8434-1, ISO 8434-4

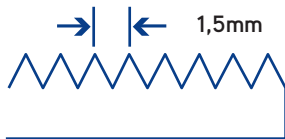
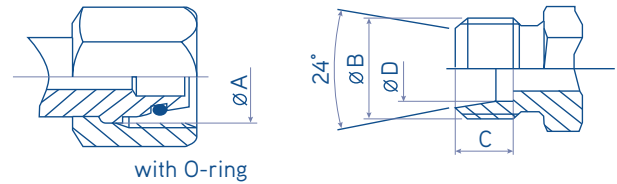

Thread

Defined by the outside diameter and the pitch
(distance between 2 crests of the thread)
example: M22x1.5 - pitch of 1.5mm.

Tube O.D. (mm)	Tube type	Thread metric	ØA (mm)	ØB (mm)	C (mm)	ØD (mm)
6.00	6L	M12X1.5	10.50	12.00	7.00	6.00
6.00	6S	M14X1.5	12.50	14.00	7.00	6.00
8.00	8L	M14x1.5	12.50	14.00	7.00	8.00
8.00	8S	M16x1.5	14.50	16.00	7.00	8.00
10.0	10L	M16x1.5	14.50	16.00	7.00	10.0
10.0	10S	M18x1.5	16.50	18.00	7.50	10.0
12.0	12L	M18x1.5	16.50	18.00	7.00	12.0
12.0	12S	M20x1.5	18.50	20.00	7.50	12.0
14.0	14S	M22x1.5	20.50	22.00	8.00	14.0
15.0	15L	M22x1.5	20.50	22.00	7.00	15.0
16.0	16S	M24x1.5	22.5	24.0	8.5	16.0
18.0	18L	M26x1.5	24.5	26.0	7.50	18.0
20.0	20S	M30x2.0	27.9	30.0	10.50	20.0
22.0	22L	M30x2.0	27.9	30.0	7.50	22.0
25.0	25S	M36x2.0	33.9	36.0	12.00	25.0
28.0	28L	M36x2.0	33.9	36.0	7.50	28.0
30.0	30S	M42x2.0	39.9	42.0	13.50	30.0
35.0	35L	M45x2.0	42.9	45.0	10.50	35.0
38.0	38S	M52x2.0	49.9	52.0	16.00	38.0
42.0	42L	M52x2.0	49.9	52.0	11.00	42.0



British Standard Pipe Parallel (BSPP)

Referred to as Whitworth threads, the BSP thread type fittings seal use metal-to-metal angled surfaces or a combination of metal-to-metal and an O-ring. The angle of the sealing surfaces is 60° for both forms.

Standard: BS 5200 ISO 12151-6

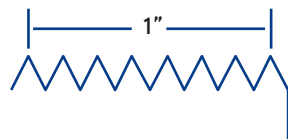
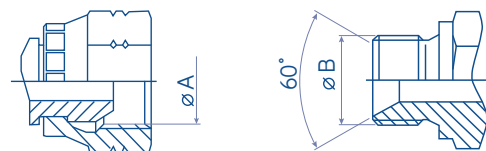

Thread

Identification is made by measuring the outside diameter of the thread and the number of threads per inch (25.4mm).

Tube I.D. (mm)	Tube O.D. (mm)	Size	Thread BSP	ØA (mm)	ØB (mm)
6	10	- 2	1/8" -28	8.60	9.70
8	13	- 4	1/4" -19	11.50	13.20
12	17	- 6	3/8" -19	14.90	16.70
15	21	- 8	1/2" -14	18.60	20.90
18	23	- 10	5/8" -14	20.60	22.90
20	27	- 12	3/4" -14	24.10	26.40
26	34	- 16	1" -11	30.3	33.20
33	42	- 20	1.1/4" -11	38.90	41.90
40	49	- 24	1.1/2" -11	44.90	47.80
50	60	- 32	2" -11	56.70	59.60

British Standard Pipe Tapered (BSPT)

Fittings seal through the thread interface mechanism. Care should be taken not to confuse the BSPT fitting with the NPTF male fitting. BSPT has a 55° thread angle.

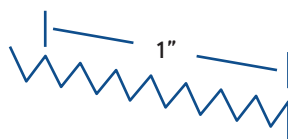
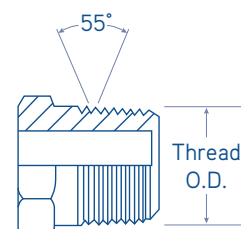

Thread

Identification is made by measuring the outside diameter of the thread and the number of threads per inch (25.4mm).

Tube I.D. (mm)	Tube O.D. (mm)	Size	Thread BSPT	ØA (mm)
5	10	- 2	1/8" -28	9.73
8	13	- 4	1/4" -19	13.16
12	17	- 6	3/8" -19	16.66
15	21	- 8	1/2" -14	20.96
20	27	- 12	3/4" -14	26.44
26	34	- 16	1" -11	33.25
33	42	- 20	1.1/4" -11	41.91
40	49	- 24	1.1/2" -11	47.80
50	60	- 32	2" -11	59.61
50	60	- 32	2" -11	56.70

BSP Flat Seal

These fittings have BSP parallel threads but the sealing surface is flat. The seal is made when the composite seal is compressed against the female flat face.

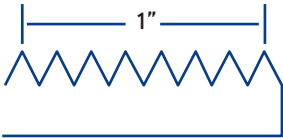
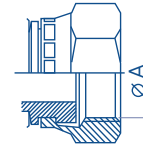

Thread

Identification is made by measuring the outside diameter of the thread and the number of threads per inch (25.4mm).

Tube I.D. (mm)	Tube O.D. (mm)	Size	Thread BSPT	ØA (mm)
6	10	- 2	1/8" -28	8.60
8	13	- 4	1/4" -19	11.50
12	17	- 6	3/8" -19	14.90
15	21	- 8	1/2" -14	18.60
18	23	- 12	5/8" -14	20.60
20	27	- 16	3/4" -14	24.10
26	34	- 20	1" -11	30.30
33	42	- 20	1.1/4" -11	38.90
40	49	- 24	1.1/2" -11	44.90
50	60	- 32	2" -11	56.70

Dry Seal American Standard Taper Pipe Thread (NPTF)

This type of fitting uses the thread interface to seal and as such has a tapered thread that deforms and forms the seal. They have 30° sealing angle surfaces, forming a 60° inverted (concave) seat.

Standard: SAE J476 / ANSI/ASME B1.20.1

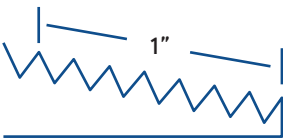
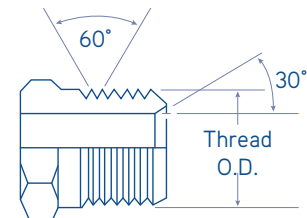

Thread

Identification is made by measuring the outside diameter of the thread and the number of threads per inch (25.4mm).

Size	Thread NPTF	ØA (mm)
- 2	1/8" -27	10.24
- 4	1/4" -18	13.61
- 6	3/8" -18	17.05
- 8	1/2" -14	21.22
- 12	3/4" -14	26.56
- 16	1" -11.5	33.22
- 20	1.1/4" -11.5	41.98
- 24	1.1/2" -11.5	48.05
- 32	2" -11.5	60.09



SAE JIC 37°

Commonly referred to as JIC fittings, these metal-to-metal sealing type fittings have a 37° flare (sealing surface angle) and straight United National Fine Threads (UNF). The original design specification for the fittings comes from the Society of Automotive Engineers (SAE).

Standard: ISO 12151-5, ISO 8434-2, SAE J516

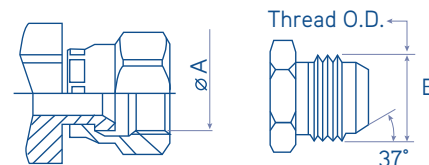

Tube O.D (inch)	Size	Thread UNF	ØA (mm)	ØB (mm)
1/4"	- 4	7/16" -20	10.00	11.10
5/16"	- 5	1/2" -20	11.60	12.70
3/8"	- 6	9/16" -18	13.00	14.30
1/2"	- 8	3/4" -16	17.60	19.10
5/8"	- 10	7/8" -14	20.50	22.20
3/4"	- 12	1.1/16" -12	24.60	27.00
7/8"	- 14	1.3/16" -12	28.30	30.10
1"	- 16	1.5/16" -12	31.30	33.30
1.1/4"	- 20	1.5/8" -12	39.20	41.30
1.1/2"	- 24	1.7/8" -12	45.60	47.60
2"	- 32	2.1/2" -12	61.50	63.50

O-Ring Face Seal (ORFS)

This fitting type have high level of sealing and good vibration resistance.

The fittings use the O-ring compression mechanism to seal. The female fittings have flat faces and straight threaded UNF swivel nuts. The male fittings have the O-ring in a groove in the flat face.

Standard: ISO 12151-1, ISO 8434-3, SAE J516

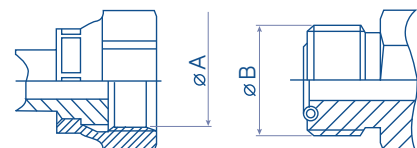

Tube O.D (inch)	Size	Thread UNF	ØA (mm)	ØB (mm)
1/4"	- 4	9/16" -18	13.00	14.20
3/8"	- 6	11/16" -16	15.90	17.50
1/2"	- 8	13/16" -16	19.10	20.60
5/8"	- 10	1" -14	23.80	25.40
3/4"	- 12	1.3/16" -12	28.20	30.10
1"	- 16	1.7/16" -12	34.15	36.50
1.1/4"	- 20	1.11/16" -12	40.50	42.90
1.1/2"	- 24	2" -12	48.80	50.80

Flange 3000 psi and 6000 psi

The sealing mechanism is through compression of the O-ring in the face of the flange head against the surface of the port connection. The flange fittings are generally separated into two pressure classes referred to as 21.0 MPa/ 3000 psi (SFL) or 42.0 MPa/ 6000 psi (SFS). In addition to these flanges, customer-specific Komatsu and CATERPILLAR flanges can also be found in the market.

Standard: ISO 6162-1, ISO 6162-2

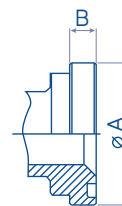

Flange (inch)	Size	3000 psi			6000 psi			SuperCat		
		ØA (mm)	B (mm)	O-ring (mm)	ØA (mm)	B (mm)	O-ring (mm)	ØA (mm)	B (mm)	O-ring (mm)
1/2"	- 8	30.18	6.73	18.64x3.53	31.75	7.75	18.64x3.53	31.75	14.22	18.64x3.53
5/8"*	- 10	34.25	6.00	21.70x3.53						
3/4"	- 12	38.10	6.73	24.99x3.53	41.28	8.76	24.99x3.53	41.28	14.22	24.99x3.53
1"	- 16	44.45	8.00	32.92x3.53	47.63	9.53	32.92x3.53	47.63	14.22	32.92x3.53
1.1/4"	- 20	50.80	8.00	37.69x3.53	53.98	10.29	37.69x3.53	53.98	14.22	37.69x3.53
1.1/2"	- 24	60.33	8.00	47.22x3.53	63.50	12.57	47.22x3.53	63.50	14.22	47.22x3.53
2"	- 32	71.42	9.53	56.74x3.53	79.38	12.57	56.74x3.53	79.38	14.22	56.74x3.53
2.1/2"	- 40	84.12	9.53	69.44x3.53						
3"	- 48	101.60	9.53	85.32x3.53						

* Although not in the SAE or the ISO standard the size -10 (5/8) flange head is gaining popularity. This flange is often found on Komatsu equipment or hydrostatic drives in agricultural machines.

Japanese Industrial Standard (JIS)

The Japanese Industrial Standard (JIS) uses a 30° sealing angle seat and either British Standard Pipe Parallel or metric threads.

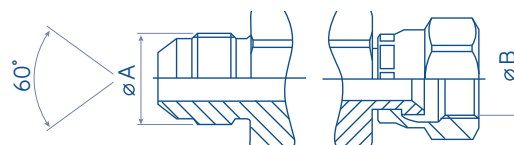

Thread metric	ØA (mm)	ØB (mm)	Thread BSP	ØA (mm)	ØB (mm)
M14X1.5	12.50	14.00	1/4" -19	11.50	13.20
M18X1.5	16.50	18.00	3/8" -19	14.90	16.70
M16X1.5	14.50	16.00	1/2" -14	18.60	20.90
M18X1.5	16.50	18.00	3/4" -14	24.10	26.40
M22X1.5	20.50	22.00	1" -11	30.30	33.20
M24X1.5	22.50	24.00			
M30X1.5	28.50	30.00			
M33X2.0	31.00	33.00			
M42X2.0	40.00	42.00			

BF21

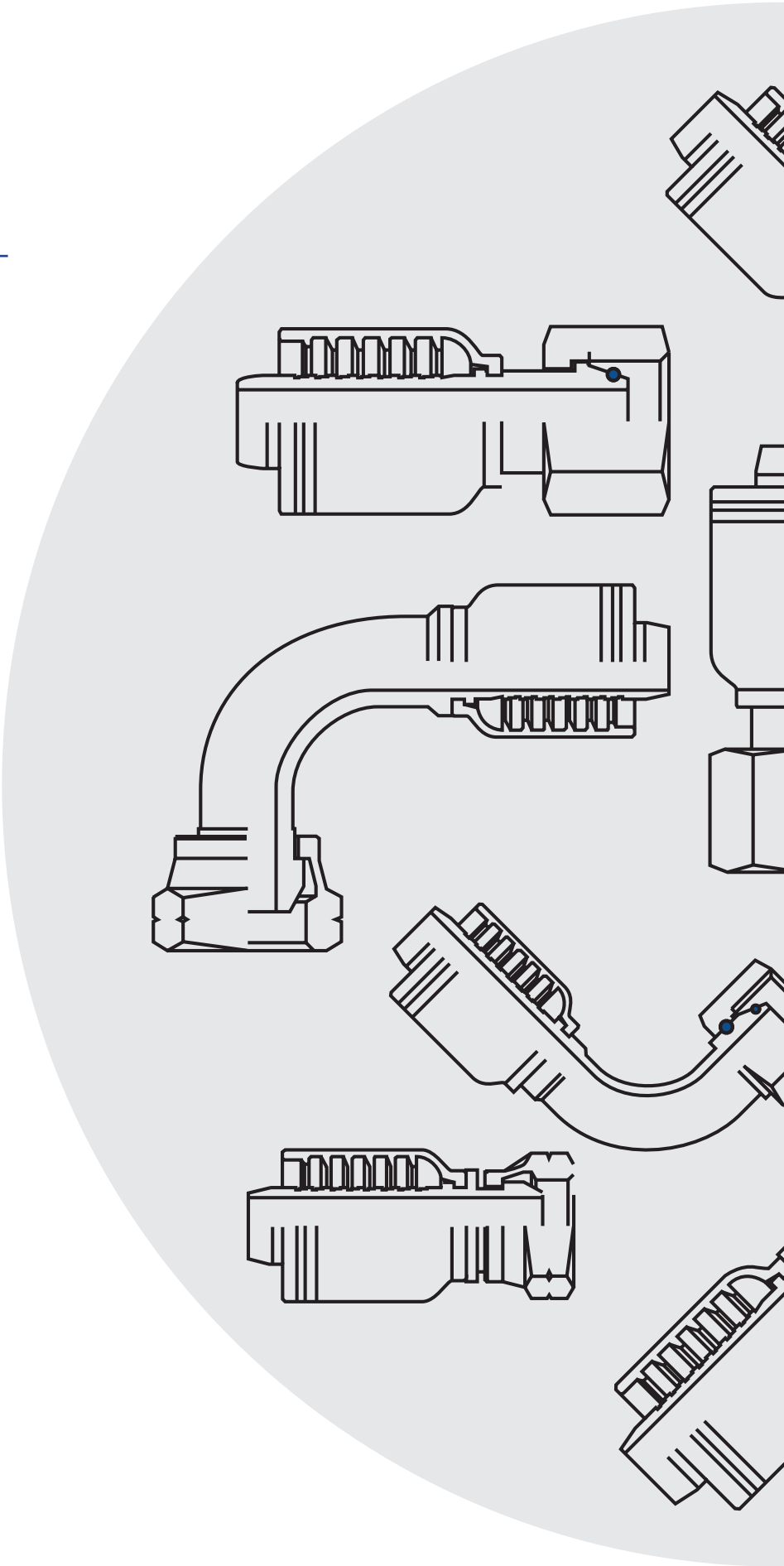

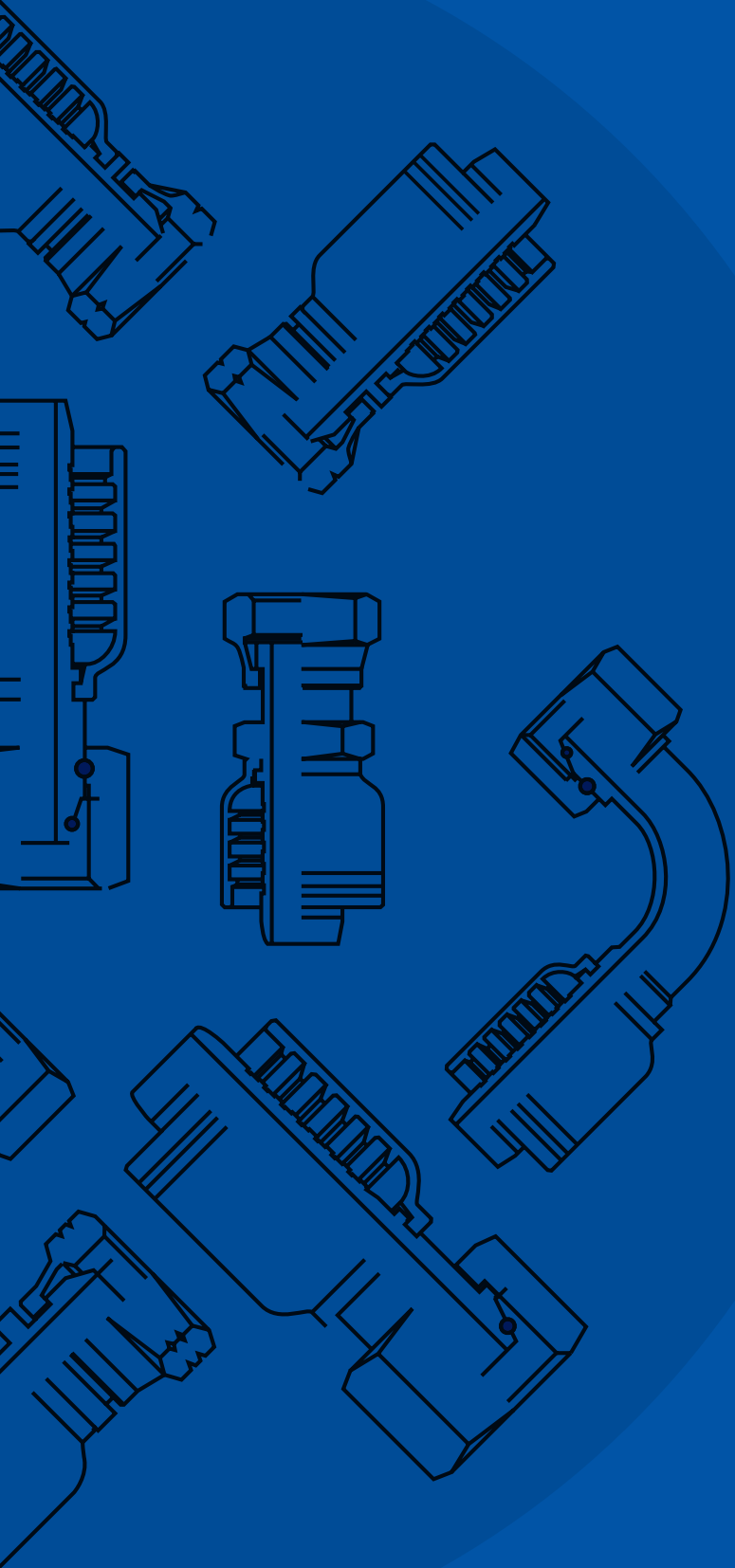

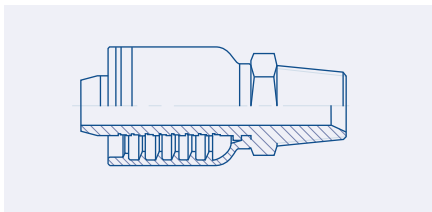

Male NPTF Pipe Rigid - MP

BF21.0400.

pag. 19

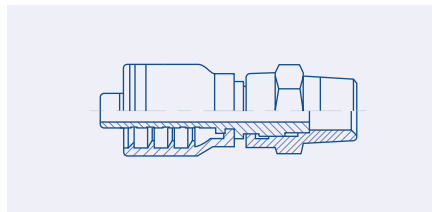

Male NPTF Swivel - MPX

BF21.0410.

pag. 20

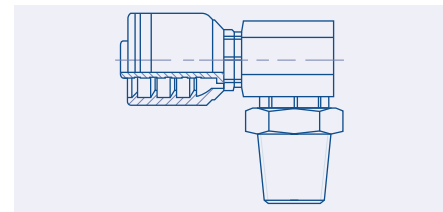

Male NPTF Swivel 90° Elbow - MPX90

BF21.0490.

pag. 21

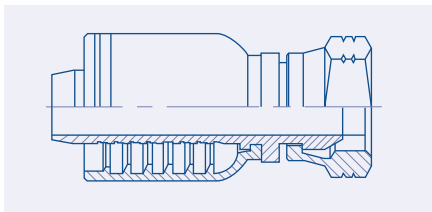

Female NPSM Pipe Swivel - FPX

BF21.3010.

pag. 22

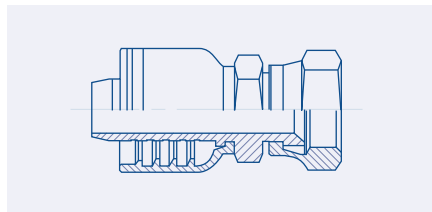

Female JIC 37° Swivel - FJ

BF21.4H12.

pag. 23

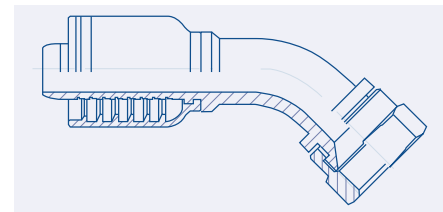

Female JIC 37° Swivel 45° Elbow - FJ45

BF21.4042.

pag. 24

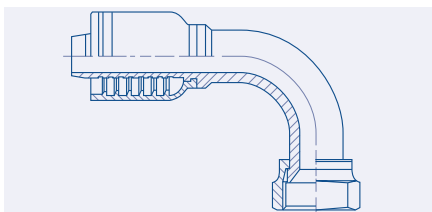

Female JIC 37° Swivel 90° Elbow - FJ90

BF21.4092.

pag. 25

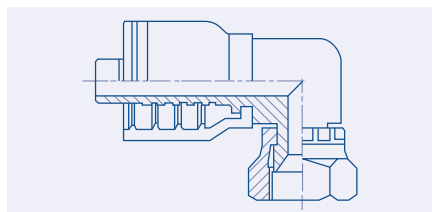

Female JIC 37° Swivel 90° Short Elbow - FJ90S

BF21.4082.

pag. 26

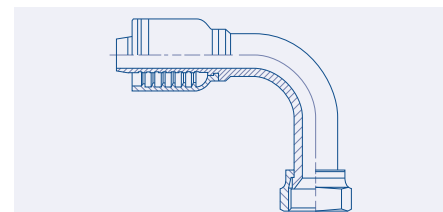

Female JIC 37° Swivel 90° Long Elbow - FJ90L

BF21.4092L.

pag. 27

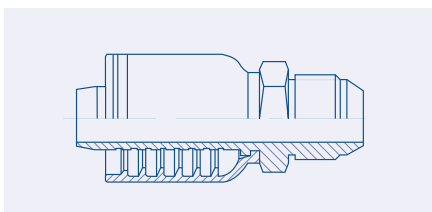

Male JIC 37° Rigid - MJ

BF21.2000.

pag. 28

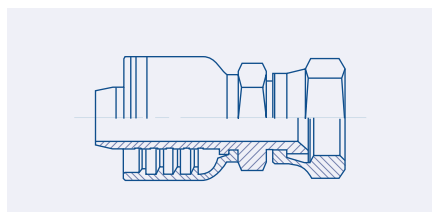

Female SAE 45° Swivel - FX

BF21.SH12.

pag. 29

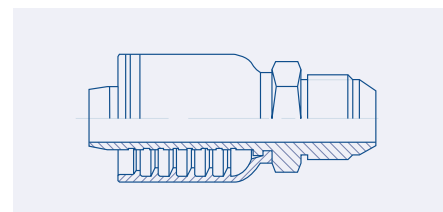

Male SAE 45° Rigid - MX

BF21.2S00.

pag. 29

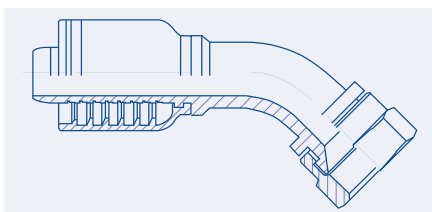

Female SAE 45° Swivel 45° Elbow - FX45

BF21.4S42.

pag. 30

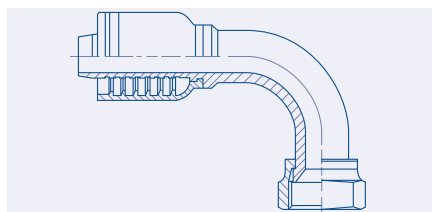

Female SAE 45° Swivel 90° Elbow - FX90

BF21.4S92.

pag. 30

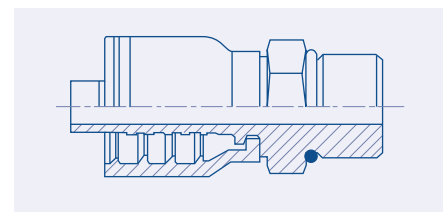

SAE Straight O-ring Boss Male - RA

BF21.2010.

pag. 31

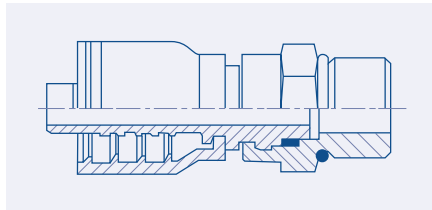

SAE Straight Swivel O-ring Boss Male - RAX

BF21.2012.

pag. 32

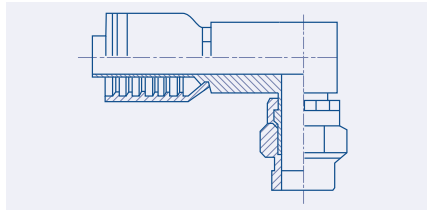

SAE 90° Elbow Swivel O-ring Boss Male - RAX90

BF21.2092.

pag. 33

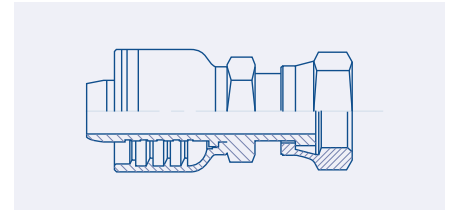

Female ORFS Swivel - OFT

BF21.44H4.

pag. 34

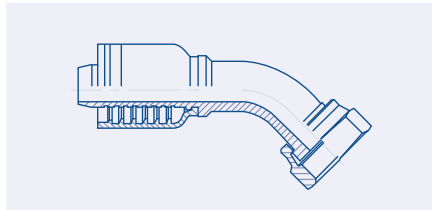

Female ORFS Swivel 45° Elbow- OFT45

BF21.4444.

pag. 35

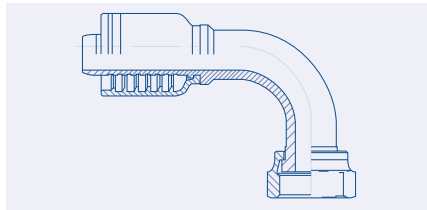

Female ORFS Swivel 90° Elbow - OFT90

BF21.4494.

pag. 36

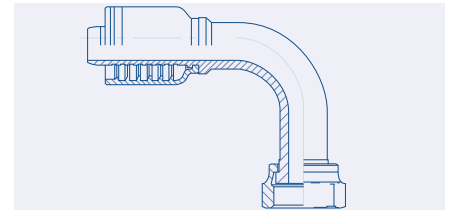

Female ORFS Swivel 90° Long Elbow - OFT90

BF21.4494L.

pag. 37

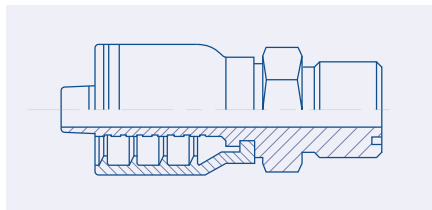

Male ORFS - OFTM

BF21.4000.

pag. 38

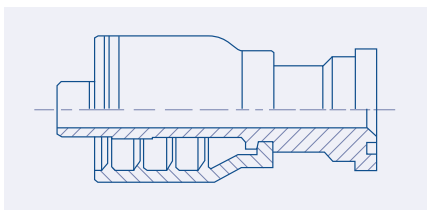

Straight SAE 3000 PSI Code 61 Flange - PA

BF21.7013.

pag. 39

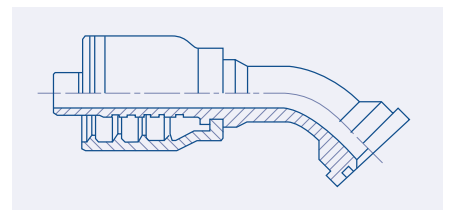

45° Elbow SAE 3000 PSI Code 61 Flange - PA45

BF21.7043.

pag. 40

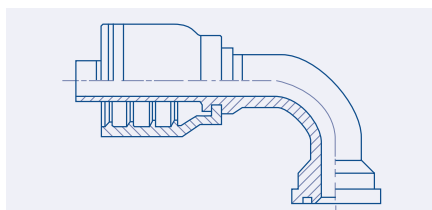

90° Elbow SAE 3000 PSI Code 61 Flange - PA90

BF21.7093.

pag. 41

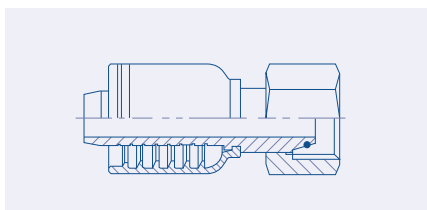

Light 24° Metric Female - DLF

BF21.5013.

pag. 42

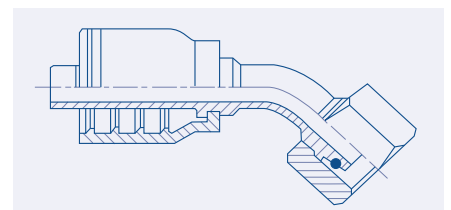

Light 24° Metric 45° Elbow Female - DLF45

BF21.5043.

pag. 43

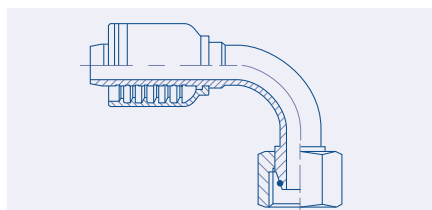

Light 24° Metric 90° Elbow Female - DLF90

BF21.5093.

pag. 44

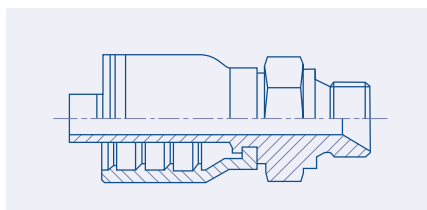

Light 24° Metric Male - DLM

BF21.1000.

pag. 45

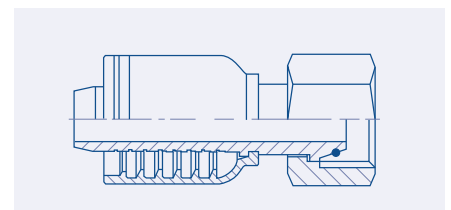

Heavy 24° Metric Female - DHF

BF21.5113.

pag. 46

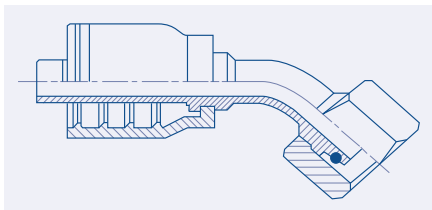

Heavy 24° Metric 45° Elbow Female - DHF45

BF21.5143.

pag. 47

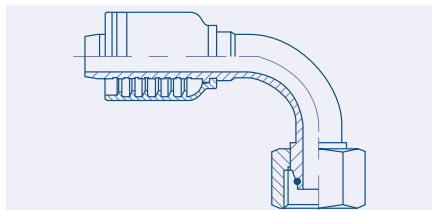

Heavy 24° Metric 90° Elbow Female - DHF90

BF21.5193.

pag. 48

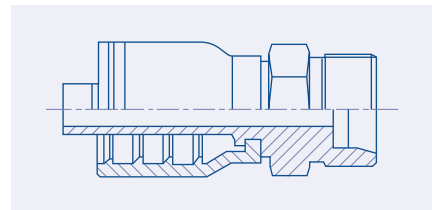

Heavy 24° Metric Male - DHM

BF21.1100.

pag. 49

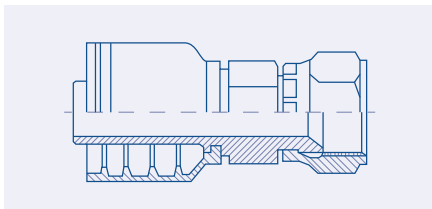

JIS 30° Female Swivel - FX-KOMA

BF21.5911.

pag. 50

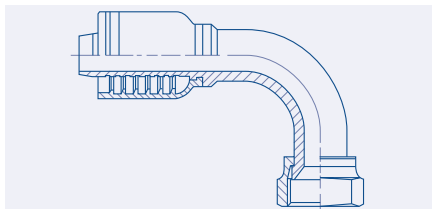

Female JIS 30° Swivel 90° Elbow - FX-KOMA90

BF21.5991.

pag. 51

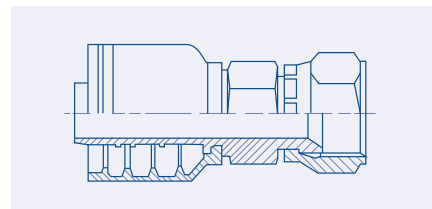

JIS 30° Female Swivel - JIS

BF21.3712.

pag. 52

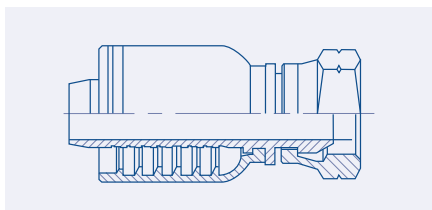

BSP 60° Swivel Female - BSPXF

BF21.3012.

pag. 53

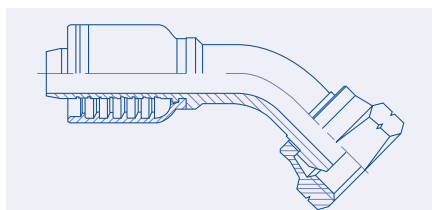

BSP 60° Swivel 45° Elbow Female - BSPXF45

BF21.3042.

pag. 54

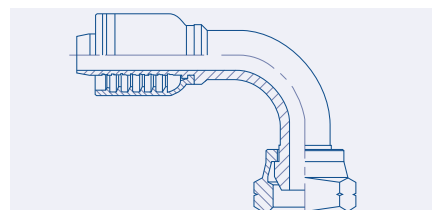

BSP 60° Swivel 90° Elbow Female - BSPXF90

BF21.3092.

pag. 55

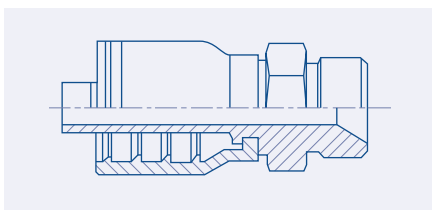

BSP 60° Male - BSPM

BF21.0100.

pag. 56



Male NPTF Pipe Rigid - MP

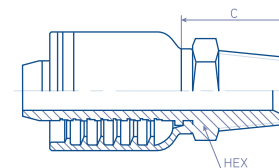

BF21.0400.

SAE J516 / SAE J514

REFERENCE	#	hose		thread	dimensions	
		dash	inch		C - Cut Off	HEX
BF2104-02MP	BF21.0400.0402	04	1/4"	1/8"-27	24,2	12
BF2104-04MP	BF21.0400.0404	04	1/4"	1/4"-18	29,7	14
BF2104-06MP	BF21.0400.0406	04	1/4"	3/8"-18	30,7	17
BF2104-08MP	BF21.0400.0408	04	1/4"	1/2"-14	35,7	22
BF2106-04MP	BF21.0400.0604	06	3/8"	1/4"-18	27,2	17
BF2106-06MP	BF21.0400.0606	06	3/8"	3/8"-18	28,7	19
BF2106-08MP	BF21.0400.0608	06	3/8"	1/2"-14	33,7	22
BF2108-04MP	BF21.0400.0804	08	1/2"	1/4"-18	31,0	19
BF2108-06MP	BF21.0400.0806	08	1/2"	3/8"-18	31,5	19
BF2108-08MP	BF21.0400.0808	08	1/2"	1/2"-14	35,5	22
BF2108-12MP	BF21.0400.0812	08	1/2"	3/4"-18	38,0	27
BF2110-08MP	BF21.0400.1008	10	5/8"	1/2"-14	37,5	22
BF2110-12MP	BF21.0400.1012	10	5/8"	3/4"-14	40,0	27
BF2112-08MP	BF21.0400.1208	12	3/4"	1/2"-14	38,8	27
BF2112-12MP	BF21.0400.1212	12	3/4"	3/4"-14	39,3	27
BF2112-16MP	BF21.0400.1216	12	3/4"	1"-11.5	45,8	36
BF2116-12MP	BF21.0400.1612	16	1"	3/4"-14	40,7	32
BF2116-16MP	BF21.0400.1616	16	1"	1"-11.5	46,2	36

MATERIAL: Carbon Steel

FINISH: Chromium-(VI) Free plating /
ROHS compliant

Suitable to be used on medium and high pressure braided hoses:

FORZA UNO R1AT/1SN; FORZA UNO "SHARK SKIN" R1AT/1SN; FORZA UNO TROPIC R1AT/1SN; FORZA DUE R2AT/2SN; FORZA DUE "SHARK SKIN" R2AT/2SN; FORZA DUE TROPIC R2AT/2SN; BALPAC PREMIUM R16/2SC; BALPAC PREMIUM "SHARK SKIN" R16/2SC; BALPAC PREMIUM TROPIC R16/2SC; IMPACTUS 5K; IMPACTUS 6K; BALPAC 3000 R17/1SC; BALPAC 3000 "SHARK SKIN" R17/1SC; 2-MAX JACK; BALWASH 1W; BALWASH 2W

Male NPTF Swivel - MPX

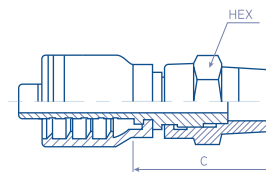

BF21.0410.

SAE J516 / SAE J514

REFERENCE	#	hose		thread	dimensions	
		dash	inch		C - Cut Off	HEX
BF2104-02MPX	BF21.0410.0402	04	1/4"	1/8"-27	37,3	17
BF2104-04MPX	BF21.0410.0404	04	1/4"	1/4"-18	37,5	17
BF2104-06MPX	BF21.0410.0406	04	1/4"	3/8"-18	35,7	19
BF2106-04MPX	BF21.0410.0604	06	3/8"	1/4"-18	35,5	17
BF2106-06MPX	BF21.0410.0606	06	3/8"	3/8"-18	35,2	19
BF2106-08MPX	BF21.0410.0608	06	3/8"	1/2"-14	42,0	22
BF2108-06MPX	BF21.0410.0806	08	1/2"	3/8"-18	36,0	19
BF2108-08MPX	BF21.0410.0808	08	1/2"	1/2"-14	42,2	22
BF2108-12MPX	BF21.0410.0812	08	1/2"	3/4"-14	41,2	32
BF2110-08MPX	BF21.0410.1008	12	3/4"	1/2"-14	42,2	22
BF2110-12MPX	BF21.0410.1012	10	5/8"	3/4"-14	42,0	32
BF2112-08MPX	BF21.0410.1208	12	3/4"	1/2"-14	42,2	22
BF2112-12MPX	BF21.0410.1212	12	3/4"	3/4"-14	41,2	32
BF2116-16MPX	BF21.0410.1616	16	1"	1"-11.5	47,5	38

MATERIAL: Carbon Steel

FINISH: Chromium-(VI) Free plating / ROHS compliant

Suitable to be used on medium and high pressure braided hoses:

FORZA UNO R1AT/1SN; FORZA UNO "SHARK SKIN" R1AT/1SN; FORZA UNO TROPIC R1AT/1SN; FORZA DUE R2AT/2SN; FORZA DUE "SHARK SKIN" R2AT/2SN; FORZA DUE TROPIC R2AT/2SN; BALPAC PREMIUM R16/2SC; BALPAC PREMIUM "SHARK SKIN" R16/2SC; BALPAC PREMIUM TROPIC R16/2SC; IMPACTUS 5K; IMPACTUS 6K; BALPAC 3000 R17/1SC; BALPAC 3000 "SHARK SKIN" R17/1SC; 2-MAX JACK; BALWASH 1W; BALWASH 2W



Male NPTF Swivel 90° Elbow - MPX90

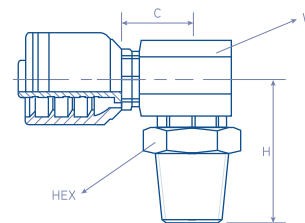

BF21.0490.

SAE J516 / SAE J514

REFERENCE	#	hose		thread	dimensions			
		dash	inch		C - Cut Off	H	W	HEX
BF2104-02MPX90	BF21.0490.0402	04	1/4"	1/8"-27	22,7	40,1	17	17
BF2104-04MPX90	BF21.0490.0404	04	1/4"	1/4"-18	22,7	40,1	17	17
BF2104-06MPX90	BF21.0490.0406	04	1/4"	3/8"-18	22,7	39,3	17	19
BF2106-04MPX90	BF21.0490.0604	06	3/8"	1/4"-18	21,0	40,9	17	17
BF2106-06MPX90	BF21.0490.0606	06	3/8"	3/8"-18	21,0	38,5	17	19
BF2106-08MPX90	BF21.0490.0608	06	3/8"	1/2"-14	23,5	40,1	24	22
BF2108-06MPX90	BF21.0490.0806	08	1/2"	3/8"-18	26,5	41,0	22	19
BF2108-08MPX90	BF21.0490.0808	08	1/2"	1/2"-14	26,5	47,0	22	22
BF2112-12MPX90	BF21.0490.1212	12	3/4"	3/4"-14	28,8	49,7	27	32
BF2116-16MPX90	BF21.0490.1616	16	1"	1"-11.5	42,7	60,0	32	38

MATERIAL: Carbon Steel

FINISH: Chromium-(VI) Free plating /
ROHS compliant

Suitable to be used on medium and high pressure braided hoses:

FORZA UNO R1AT/1SN; FORZA UNO "SHARK SKIN" R1AT/1SN; FORZA UNO TROPIC R1AT/1SN; FORZA DUE R2AT/2SN; FORZA DUE "SHARK SKIN" R2AT/2SN; FORZA DUE TROPIC R2AT/2SN; BALPAC PREMIUM R16/2SC; BALPAC PREMIUM "SHARK SKIN" R16/2SC; BALPAC PREMIUM TROPIC R16/2SC; IMPACTUS 5K; IMPACTUS 6K; BALPAC 3000 R17/1SC; BALPAC 3000 "SHARK SKIN" R17/1SC; 2-MAX JACK; BALWASH 1W; BALWASH 2W

Female NPSM Pipe Swivel - FPX

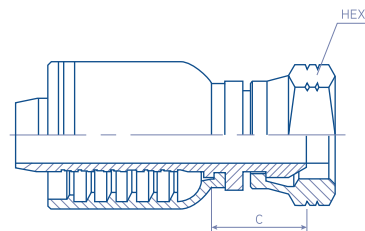

BF21.3010.

SAE J516 / SAE J514

REFERENCE	#	hose		thread	dimensions	
		dash	inch		C - Cut Off	HEX
BF2104-02FPX	BF21.3010.0402	04	1/4"	1/8"-18	23,7	14
BF2104-04FPX	BF21.3010.0404	04	1/4"	1/4"-18	26,7	19
BF2104-06FPX	BF21.3010.0406	04	1/4"	3/8"-18	29,1	22
BF2106-06FPX	BF21.3010.0606	06	3/8"	3/8"-18	27,2	22
BF2106-08FPX	BF21.3010.0608	06	3/8"	1/2"-14	29,0	27
BF2108-08FPX	BF21.3010.0808	08	1/2"	1/2"-14	30,7	27
BF2112-12FPX	BF21.3010.1212	12	3/4"	3/4"-18	35,3	32
BF2116-16FPX	BF21.3010.1616	16	1"	1"-11.5	38,0	41

MATERIAL: Carbon Steel

FINISH: Chromium-(VI) Free plating / ROHS compliant

Suitable to be used on medium and high pressure braided hoses:

FORZA UNO R1AT/1SN; FORZA UNO "SHARK SKIN" R1AT/1SN; FORZA UNO TROPIC R1AT/1SN; FORZA DUE R2AT/2SN; FORZA DUE "SHARK SKIN" R2AT/2SN; FORZA DUE TROPIC R2AT/2SN; BALPAC PREMIUM R16/2SC; BALPAC PREMIUM "SHARK SKIN" R16/2SC; BALPAC PREMIUM TROPIC R16/2SC; IMPACTUS 5K; IMPACTUS 6K; BALPAC 3000 R17/1SC; BALPAC 3000 "SHARK SKIN" R17/1SC; 2-MAX JACK; BALWASH 1W; BALWASH 2W



Female JIC 37° Swivel - FJ

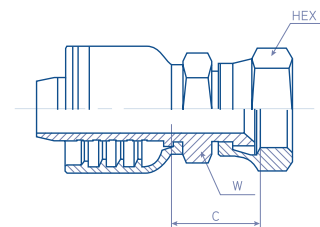

BF21.4H12.

ISO 12151-5 / ISO 8434-2 / SAE J516 / SAE J514

REFERENCE	#	hose		thread	dimensions		
		dash	inch		C - Cut Off	W	HEX
BF2104-04FJ	BF21.4H12.0404	04	1/4"	7/16"-20	22,7	14	14
BF2104-05FJ	BF21.4H12.0405	04	1/4"	1/2"-20	22,7	14	16
BF2104-06FJ	BF21.4H12.0406	04	3/8"	9/16"-18	24,7	14	19
BF2106-04FJ	BF21.4H12.0604	06	3/8"	7/16"-20	20,2	17	14
BF2106-06FJ	BF21.4H12.0606	06	3/8"	9/16"-18	20,7	17	19
BF2106-08FJ	BF21.4H12.0608	06	3/8"	3/4"-16	26,0	19	22
BF2106-10FJ	BF21.4H12.0610	06	3/8"	7/8"-14	28,5	22	27
BF2108-06FJ	BF21.4H12.0806	08	1/2"	9/16"-18	25,0	22	19
BF2108-08FJ	BF21.4H12.0808	08	1/2"	3/4"-16	27,0	22	22
BF2108-10FJ	BF21.4H12.0810	08	1/2"	7/8"-14	30,0	22	27
BF2108-12FJ	BF21.4H12.0812	08	1/2"	1.1/16"-12	34,0	25	32
BF2110-08FJ	BF21.4H12.1008	10	5/8"	3/4"-16	28,5	22	22
BF2110-10FJ	BF21.4H12.1010	10	5/8"	7/8"-14	30,5	22	27
BF2110-12FJ	BF21.4H12.1012	10	5/8"	1.1/16"-12	35,5	27	32
BF2112-10FJ	BF21.4H12.1210	12	3/4"	7/8"-14	33,3	27	27
BF2112-12FJ	BF21.4H12.1212	12	3/4"	1.1/16"-12	34,8	27	32
BF2112-14FJ	BF21.4H12.1214	12	3/4"	1.3/16"-12	36,3	32	38
BF2112-16FJ	BF21.4H12.1216	12	3/4"	1.5/16"-12	36,3	32	38
BF2116-12FJ	BF21.4H12.1612	16	1"	1.3/16"-12	34,2	32	32
BF2116-16FJ	BF21.4H12.1616	16	1"	1.5/16"-12	35,7	32	38

MATERIAL: Carbon Steel

FINISH: Chromium-(VI) Free plating /
ROHS compliant

Suitable to be used on medium and high pressure braided hoses:

FORZA UNO R1AT/1SN; FORZA UNO "SHARK SKIN" R1AT/1SN; FORZA UNO TROPIC R1AT/1SN; FORZA DUE R2AT/2SN; FORZA DUE "SHARK SKIN" R2AT/2SN; FORZA DUE TROPIC R2AT/2SN; BALPAC PREMIUM R16/2SC; BALPAC PREMIUM "SHARK SKIN" R16/2SC; BALPAC PREMIUM TROPIC R16/2SC; IMPACTUS 5K; IMPACTUS 6K; BALPAC 3000 R17/1SC; BALPAC 3000 "SHARK SKIN" R17/1SC; 2-MAX JACK; BALWASH 1W; BALWASH 2W

Female JIC 37° Swivel 45° Elbow - FJ45

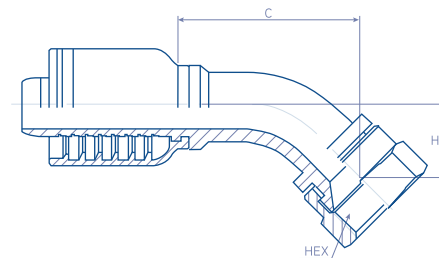

BF21.4042.

ISO 12151-5 / ISO 8434-2 / SAE J516 / SAE J514

REFERENCE	#	hose		thread	dimensions		
		dash	inch		C - Cut Off	H	HEX
BF2104-04FJ45	BF21.4042.0404	04	1/4"	7/16"-20	35,0	10,5	14
BF2104-05FJ45	BF21.4042.0405	04	1/4"	1/2"-20	35,0	10,5	16
BF2104-06FJ45	BF21.4042.0406	04	3/8"	9/16"-18	35,0	10,5	19
BF2106-06FJ45	BF21.4042.0606	06	3/8"	9/16"-18	38,5	14,5	19
BF2106-08FJ45	BF21.4042.0608	06	3/8"	3/4"-16	41,0	16,0	22
BF2106-10FJ45	BF21.4042.0610	06	3/8"	7/8"-14	40,0	16,5	27
BF2108-08FJ45	BF21.4042.0808	08	1/2"	3/4"-16	44,5	18,0	22
BF2108-10FJ45	BF21.4042.0810	08	1/2"	7/8"-14	46,5	21,3	27
BF2108-12FJ45	BF21.4042.0812	08	1/2"	1.1/16"-12	48,0	23,0	32
BF2110-10FJ45	BF21.4042.1010	10	5/8"	7/8"-14	52,0	21,3	27
BF2110-12FJ45	BF21.4042.1012	10	5/8"	1.1/16"-12	64,0	27,0	32
BF2112-12FJ45	BF21.4042.1212	12	3/4"	1.1/16"-12	70,0	27,0	32
BF2112-16FJ45	BF21.4042.1216	12	3/4"	1.5/16"-12	72,0	30,0	38
BF2116-16FJ45	BF21.4042.1616	16	1"	1.5/16"-12	77,0	32,0	38

MATERIAL: Carbon Steel

FINISH: Chromium-(VI) Free plating /
ROHS compliant

Suitable to be used on medium and high pressure braided hoses:

FORZA UNO R1AT/1SN; FORZA UNO "SHARK SKIN" R1AT/1SN; FORZA UNO TROPIC R1AT/1SN; FORZA DUE R2AT/2SN; FORZA DUE "SHARK SKIN" R2AT/2SN; FORZA DUE TROPIC R2AT/2SN; BALPAC PREMIUM R16/2SC; BALPAC PREMIUM "SHARK SKIN" R16/2SC; BALPAC PREMIUM TROPIC R16/2SC; IMPACTUS 5K; IMPACTUS 6K; BALPAC 3000 R17/1SC; BALPAC 3000 "SHARK SKIN" R17/1SC; 2-MAX JACK; BALWASH 1W; BALWASH 2W



Female JIC 37° Swivel 90° Elbow - FJ90

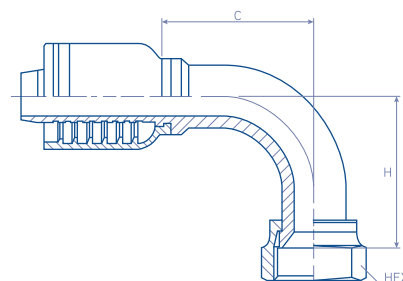

BF21.4092.

ISO 12151-5 / ISO 8434-2 / SAE J516 / SAE J514

REFERENCE	#	hose		thread	dimensions		
		dash	inch		C - Cut Off	H	HEX
BF2104-04FJ90	BF21.4092.0404	04	1/4"	7/16"-20	26,0	24,5	14
BF2104-05FJ90	BF21.4092.0405	04	1/4"	1/2"-20	29,0	25,0	16
BF2104-06FJ90	BF21.4092.0406	04	3/8"	9/16"-18	29,0	25,0	19
BF2106-06FJ90	BF21.4092.0606	06	3/8"	9/16"-18	34,0	31,5	19
BF2106-08FJ90	BF21.4092.0608	06	3/8"	3/4"-16	35,0	30,0	22
BF2106-10FJ90	BF21.4092.0610	06	3/8"	7/8"-14	37,1	38,0	27
BF2108-08FJ90	BF21.4092.0808	08	1/2"	3/4"-16	42,5	40,0	22
BF2108-10FJ90	BF21.4092.0810	08	1/2"	7/8"-14	37,0	40,5	27
BF2108-12FJ90	BF21.4092.0812	08	1/2"	1 1/16"-12	47,0	50,0	32
BF2110-10FJ90	BF21.4092.1010	10	5/8"	7/8"-14	50,0	47,5	27
BF2110-12FJ90	BF21.4092.1012	10	5/8"	1 1/16"-12	54,0	55,0	32
BF2112-12FJ90	BF21.4092.1212	12	3/4"	1 1/16"-12	55,5	55,0	32
BF2112-16FJ90	BF21.4092.1216	12	3/4"	1 5/16"-12	55,5	65,0	38
BF2116-16FJ90	BF21.4092.1616	16	1"	1 5/16"-12	72,0	71,0	38

MATERIAL: Carbon Steel

FINISH: Chromium-(VI) Free plating /
ROHS compliant

Suitable to be used on medium and high pressure braided hoses:

FORZA UNO R1AT/1SN; FORZA UNO "SHARK SKIN" R1AT/1SN; FORZA UNO TROPIC R1AT/1SN; FORZA DUE R2AT/2SN; FORZA DUE "SHARK SKIN" R2AT/2SN; FORZA DUE TROPIC R2AT/2SN; BALPAC PREMIUM R16/2SC; BALPAC PREMIUM "SHARK SKIN" R16/2SC; BALPAC PREMIUM TROPIC R16/2SC; IMPACTUS 5K; IMPACTUS 6K; BALPAC 3000 R17/1SC; BALPAC 3000 "SHARK SKIN" R17/1SC; 2-MAX JACK; BALWASH 1W; BALWASH 2W

Female JIC 37° Swivel 90° Short Elbow - FJ90S

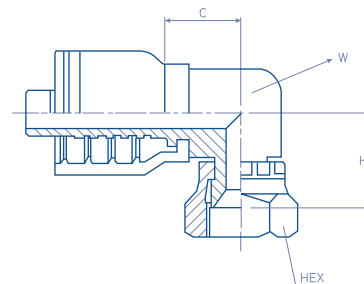

BF21.4082.

ISO 12151-5 / ISO 8434-2 / SAE J516 / SAE J514

REFERENCE	#	hose		thread	dimensions			
		dash	inch		C - Cut Off	H	W	HEX
BF2104-04FJ90S	BF21.4082.0404	04	1/4"	7/16"-20	18,5	19,6	11	14
BF2104-05FJ90S	BF21.4082.0405	04	1/4"	1/2"-20	18,5	21,5	14	16
BF2104-06FJ90S	BF21.4082.0406	04	3/8"	9/16"-18	18,5	21,8	14	19
BF2106-06FJ90S	BF21.4082.0606	06	3/8"	9/16"-18	21,5	25,5	16	19
BF2106-08FJ90S	BF21.4082.0608	06	3/8"	3/4"-16	21,5	26,5	19	22
BF2108-08FJ90S	BF21.4082.0808	08	1/2"	3/4"-16	25,5	29,5	19	22
BF2108-10FJ90S	BF21.4082.0810	08	1/2"	7/8"-14	25,5	28,0	22	27
BF2110-10FJ90S	BF21.4082.1010	10	5/8"	7/8"-14	25,5	28,0	22	27
BF2112-12FJ90S	BF21.4082.1212	12	3/4"	1.1/16"-12	30,8	28,5	30,7	28,5
BF2112-16FJ90S	BF21.4082.1216	12	3/4"	1.5/16"-12	30,0	33,5	33	38
BF2116-16FJ90S	BF21.4082.1616	16	1"	1.5/16"-12	33,5	30,5	33,5	30,5

MATERIAL: Carbon Steel

FINISH: Chromium-(VI) Free plating /
ROHS compliant

Suitable to be used on medium and high pressure braided hoses:

FORZA UNO R1AT/1SN; FORZA UNO "SHARK SKIN" R1AT/1SN; FORZA UNO TROPIC R1AT/1SN; FORZA DUE R2AT/2SN; FORZA DUE "SHARK SKIN" R2AT/2SN; FORZA DUE TROPIC R2AT/2SN; BALPAC PREMIUM R16/2SC; BALPAC PREMIUM "SHARK SKIN" R16/2SC; BALPAC PREMIUM TROPIC R16/2SC; IMPACTUS 5K; IMPACTUS 6K; BALPAC 3000 R17/1SC; BALPAC 3000 "SHARK SKIN" R17/1SC; 2-MAX JACK; BALWASH 1W; BALWASH 2W



Female JIC 37° Swivel 90° Long Elbow - FJ90L

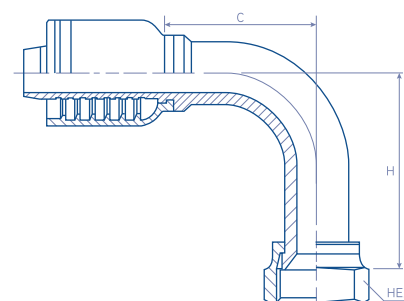

BF21.4092L.

ISO 12151-5 / ISO 8434-2 / SAE J516 / SAE J514

REFERENCE	#	hose		thread	dimensions		
		dash	inch		C - Cut Off	W	HEX
BF2104-04FJ90L	BF21.4092.0404L	04	1/4"	7/16"-20	31,9	46,0	14
BF2104-05FJ90L	BF21.4092.0405L	04	1/4"	1/2"-20	32,0	46,0	16
BF2104-06FJ90L	BF21.4092.0406L	04	3/8"	9/16"-18	31,7	46,0	19
BF2106-06FJ90L	BF21.4092.0606L	06	3/8"	9/16"-18	33,0	54,0	19
BF2106-08FJ90L	BF21.4092.0608L	06	3/8"	3/4"-16	38,0	64,0	22
BF2108-08FJ90L	BF21.4092.0808L	08	1/2"	3/4"-16	44,0	64,0	22
BF2108-10FJ90L	BF21.4092.0810L	08	1/2"	7/8"-14	46,0	65,0	27
BF2110-10FJ90L	BF21.4092.1010L	10	5/8"	7/8"-14	55,0	70,0	27
BF2112-12FJ90L	BF21.4092.1212L	12	3/4"	1.1/16"-12	56,0	96,0	32
BF2112-16FJ90L	BF21.4092.1216L	12	3/4"	1.5/16"-12	60,0	100,0	38
BF2116-16FJ90L	BF21.4092.1616L	16	1"	1.5/16"-12	76,0	114,0	38

MATERIAL: Carbon Steel

FINISH: Chromium-(VI) Free plating /
ROHS compliant

Suitable to be used on medium and high pressure braided hoses:

FORZA UNO R1AT/1SN; FORZA UNO "SHARK SKIN" R1AT/1SN; FORZA UNO TROPIC R1AT/1SN; FORZA DUE R2AT/2SN; FORZA DUE "SHARK SKIN" R2AT/2SN; FORZA DUE TROPIC R2AT/2SN; BALPAC PREMIUM R16/2SC; BALPAC PREMIUM "SHARK SKIN" R16/2SC; BALPAC PREMIUM TROPIC R16/2SC; IMPACTUS 5K; IMPACTUS 6K; BALPAC 3000 R17/1SC; BALPAC 3000 "SHARK SKIN" R17/1SC; 2-MAX JACK; BALWASH 1W; BALWASH 2W

Male JIC 37° Rigid - MJ

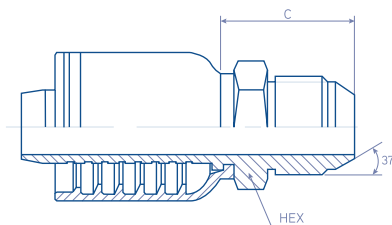

BF21.2000.

ISO 12151-5 / ISO 8434-2 / SAE J516 / SAE J514

REFERENCE	#	hose		thread	dimensions	
		dash	inch		C - Cut Off	HEX
BF2104-04MJ	BF21.2000.0404	04	1/4"	7/16"-20	27,7	14
BF2104-05MJ	BF21.2000.0405	04	1/4"	1/2"-20	28,2	14
BF2104-06MJ	BF21.2000.0406	04	1/4"	9/16"-20	28,2	17
BF2106-06MJ	BF21.2000.0606	06	3/8"	9/16"-18	27,0	17
BF2106-08MJ	BF21.2000.0608	06	3/8"	3/4"-16	31,2	19
BF2106-10MJ	BF21.2000.0610	06	3/8"	7/8"-14	48,0	24
BF2108-06MJ	BF21.2000.0806	08	1/2"	9/16"-18	29,6	19
BF2108-08MJ	BF21.2000.0808	08	1/2"	3/4"-16	32,2	22
BF2108-10MJ	BF21.2000.0810	08	1/2"	7/8"-14	37,3	24
BF2108-12MJ	BF21.2000.0812	08	1/2"	1.1/16"-12	41,4	27
BF2110-08MJ	BF21.2000.1008	10	5/8"	3/4"-16	38,0	24
BF2110-10MJ	BF21.2000.1010	10	5/8"	7/8"-14	39,3	24
BF2110-12MJ	BF21.2000.1012	10	5/8"	1.1/16"-12	42,0	27
BF2112-10MJ	BF21.2000.1210	12	3/4"	7/8"-14	40,0	27
BF2112-12MJ	BF21.2000.1212	12	3/4"	1.1/16"-12	41,7	27
BF2112-14MJ	BF21.2000.1214	12	3/4"	1.3/16"-12	46,5	32
BF2112-16MJ	BF21.2000.1216	12	3/4"	1.5/16"-12	47,1	36
BF2116-16MJ	BF21.2000.1616	16	1"	1.5/16"-12	44,5	36

MATERIAL: Carbon Steel

FINISH: Chromium-(VI) Free plating /
ROHS compliant

Suitable to be used on medium and high pressure braided hoses:

FORZA UNO R1AT/1SN; FORZA UNO "SHARK SKIN" R1AT/1SN; FORZA UNO TROPIC R1AT/1SN; FORZA DUE R2AT/2SN; FORZA DUE "SHARK SKIN" R2AT/2SN; FORZA DUE TROPIC R2AT/2SN; BALPAC PREMIUM R16/2SC; BALPAC PREMIUM "SHARK SKIN" R16/2SC; BALPAC PREMIUM TROPIC R16/2SC; IMPACTUS 5K; IMPACTUS 6K; BALPAC 3000 R17/1SC; BALPAC 3000 "SHARK SKIN" R17/1SC; 2-MAX JACK; BALWASH 1W; BALWASH 2W



Female SAE 45° Swivel - FX

BF21.SH12.

SAE J512 / SAE J513

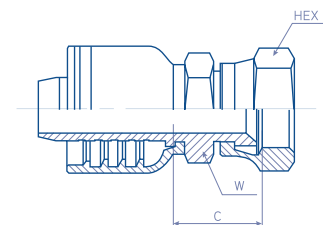

REFERENCE	#	hose dash	hose Ø inch	thread	C cut off mm	W mm	HEX mm
BF2106-06FX	BF21.SH12.0606	-6	3/8"	5/8" - 18 UNF	26.3	19	22
BF2112-12FX	BF21.SH12.1212	-12	3/4"	1.1/16" - 14 UNS	33.7	27	32

MATERIAL: Carbon Steel

FINISH: Chromium-(VI) Free plating /
ROHS compliant

VERSIONS: Stainless Steel (add an 'S'
at the end of the REFERENCE)

Suitable to be used on medium and high pressure braided hoses:

FORZA UNO R1AT/1SN; FORZA UNO "SHARK SKIN" R1AT/1SN; FORZA UNO TROPIC R1AT/1SN; FORZA DUE R2AT/2SN; FORZA DUE "SHARK SKIN" R2AT/2SN; FORZA DUE TROPIC R2AT/2SN; BALPAC PREMIUM R16/2SC; BALPAC PREMIUM "SHARK SKIN" R16/2SC; BALPAC PREMIUM TROPIC R16/2SC; IMPACTUS 5K; IMPACTUS 6K; BALPAC 3000 R17/1SC; BALPAC 3000 "SHARK SKIN" R17/1SC; 2-MAX JACK; BALWASH 1W; BALWASH 2W

Male SAE 45° Rigid - MX

BF21.2S00.

SAE J512 / SAE J513

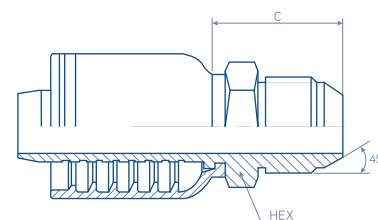

REFERENCE	#	hose dash	hose Ø inch	thread	C cut off mm	HEX mm
BF2106-06MX	BF21.2S00.0606	-6	3/8"	5/8" - 18 UNF	27.1	22
BF2112-12MX	BF21.2S00.1212	-12	3/4"	1.1/16" - 14 UNS	40.6	32

MATERIAL: Carbon Steel

FINISH: Chromium-(VI) Free plating /
ROHS compliant

VERSIONS: Stainless Steel (add an 'S'
at the end of the REFERENCE)

Suitable to be used on medium and high pressure braided hoses:

FORZA UNO R1AT/1SN; FORZA UNO "SHARK SKIN" R1AT/1SN; FORZA UNO TROPIC R1AT/1SN; FORZA DUE R2AT/2SN; FORZA DUE "SHARK SKIN" R2AT/2SN; FORZA DUE TROPIC R2AT/2SN; BALPAC PREMIUM R16/2SC; BALPAC PREMIUM "SHARK SKIN" R16/2SC; BALPAC PREMIUM TROPIC R16/2SC; IMPACTUS 5K; IMPACTUS 6K; BALPAC 3000 R17/1SC; BALPAC 3000 "SHARK SKIN" R17/1SC; 2-MAX JACK; BALWASH 1W; BALWASH 2W

Female SAE 45° Swivel 45° Elbow - FX45

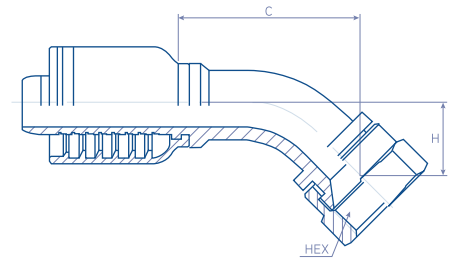

BF21.4S42.

SAE J512 / SAE J513

REFERENCE	#	hose dash	hose Ø inch	thread	C cut off mm	H mm	HEX mm
BF2106-06FX45	BF21.4S42.0606	-6	3/8"	5/8" - 18 UNF	34.0	15.5	22
BF2112-12FX45	BF21.4S42.1212	-12	3/4"	1.1/16" - 14 UNS	55.5	27.0	32

MATERIAL: Carbon Steel

FINISH: Chromium-(VI) Free plating / ROHS compliant

VERSIONS: Stainless Steel (add an 'S' at the end of the REFERENCE)

Suitable to be used on medium and high pressure braided hoses:

FORZA UNO R1AT/1SN; FORZA UNO "SHARK SKIN" R1AT/1SN; FORZA UNO TROPIC R1AT/1SN; FORZA DUE R2AT/2SN; FORZA DUE "SHARK SKIN" R2AT/2SN; FORZA DUE TROPIC R2AT/2SN; BALPAC PREMIUM R16/2SC; BALPAC PREMIUM "SHARK SKIN" R16/2SC; BALPAC PREMIUM TROPIC R16/2SC; IMPACTUS 5K; IMPACTUS 6K; BALPAC 3000 R17/1SC; BALPAC 3000 "SHARK SKIN" R17/1SC; 2-MAX JACK; BALWASH 1W; BALWASH 2W

Female SAE 45° Swivel 90° Elbow - FX90

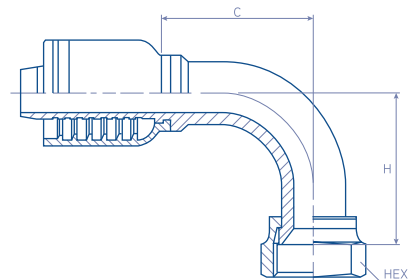

BF21.4S92.

SAE J512 / SAE J513

REFERENCE	#	hose dash	hose Ø inch	thread	C cut off mm	H mm	HEX mm
BF2106-06FX90	BF21.4S92.0606	-6	3/8"	5/8" - 18 UNF	34.0	30	22
BF2112-12FX90	BF21.4S92.1212	-12	3/4"	1.1/16" - 14 UNS	55.5	55	32

MATERIAL: Carbon Steel

FINISH: Chromium-(VI) Free plating / ROHS compliant

VERSIONS: Stainless Steel (add an 'S' at the end of the REFERENCE)

Suitable to be used on medium and high pressure braided hoses:

FORZA UNO R1AT/1SN; FORZA UNO "SHARK SKIN" R1AT/1SN; FORZA UNO TROPIC R1AT/1SN; FORZA DUE R2AT/2SN; FORZA DUE "SHARK SKIN" R2AT/2SN; FORZA DUE TROPIC R2AT/2SN; BALPAC PREMIUM R16/2SC; BALPAC PREMIUM "SHARK SKIN" R16/2SC; BALPAC PREMIUM TROPIC R16/2SC; IMPACTUS 5K; IMPACTUS 6K; BALPAC 3000 R17/1SC; BALPAC 3000 "SHARK SKIN" R17/1SC; 2-MAX JACK; BALWASH 1W; BALWASH 2W



SAE Straight O-ring Boss Male - RA

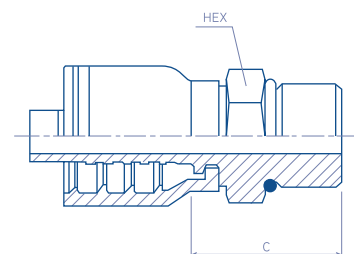

BF21.2010.

ISO 12151-5 / ISO 8434-2 / SAE J512 / SAE J513

REFERENCE	#	hose		thread	dimensions	
		dash	inch		C - Cut Off	HEX
BF2104-04RA	BF21.2010.0404	04	1/4"	7/16"-20	23,4	14
BF2106-06RA	BF21.2010.0606	06	3/8"	9/16"-18	23	17
BF2106-08RA	BF21.2010.0608	06	3/8"	3/4"-16	26,2	22
BF2108-08RA	BF21.2010.0808	08	1/2"	3/4"-16	27,9	22
BF2108-10RA	BF21.2010.0810	08	1/2"	7/8"-14	31,9	27
BF2108-12RA	BF21.2010.0812	08	1/2"	1.1/16"-12	36	32
BF2110-10RA	BF21.2010.1010	10	5/8"	7/8"-14	33,2	27
BF2110-12RA	BF21.2010.1012	10	5/8"	1.1/16"-12	37,4	32
BF2112-12RA	BF21.2010.1212	12	3/4"	1.1/16"-12	36,5	32
BF2112-16RA	BF21.2010.1216	16	1"	1.5/16"-12	39	41
BF2116-16RA	BF21.2010.1616	16	1"	1.5/16"-12	35,7	38

MATERIAL: Carbon Steel

FINISH: Chromium-(VI) Free plating /
ROHS compliant

Suitable to be used on medium and high pressure braided hoses:

FORZA UNO R1AT/1SN; FORZA UNO "SHARK SKIN" R1AT/1SN; FORZA UNO TROPIC R1AT/1SN; FORZA DUE R2AT/2SN; FORZA DUE "SHARK SKIN" R2AT/2SN; FORZA DUE TROPIC R2AT/2SN; BALPAC PREMIUM R16/2SC; BALPAC PREMIUM "SHARK SKIN" R16/2SC; BALPAC PREMIUM TROPIC R16/2SC; IMPACTUS 5K; IMPACTUS 6K; BALPAC 3000 R17/1SC; BALPAC 3000 "SHARK SKIN" R17/1SC; 2-MAX JACK; BALWASH 1W; BALWASH 2W

SAE Straight Swivel O-ring Boss Male - RAX

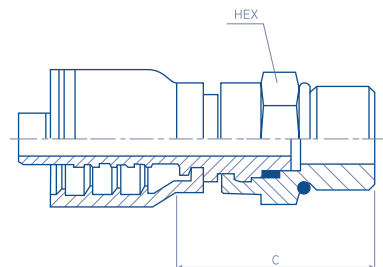

BF21.2012.

ISO 12151-5 / ISO 8434-2 / SAE J512 / SAE J513

REFERENCE	#	hose		thread	dimensions	
		dash	inch		C - Cut Off	HEX
BF2104-04RAX	BF21.2012.0404	04	1/4"	7/16"-20	39,7	19
BF2104-06RAX	BF21.2012.0406	04	1/4"	9/16"-18	40,2	19
BF2106-06RAX	BF21.2012.0606	06	3/8"	9/16"-18	38,2	19
BF2106-08RAX	BF21.2012.0608	06	3/8"	3/4"-16	42,7	22
BF2108-08RAX	BF21.2012.0808	08	1/2"	3/4"-16	44,5	22
BF2108-10RAX	BF21.2012.0810	08	1/2"	7/8"-14	38,0	27
BF2108-12RAX	BF21.2012.0812	08	1/2"	1.1/16"-12	47,3	32
BF2110-10RAX	BF21.2012.1010	10	5/8"	7/8"-14	39,5	27
BF2112-12RAX	BF21.2012.1212	12	3/4"	1.1/16"-12	48,1	32
BF2112-16RAX	BF21.2012.1216	12	3/4"	1.5/16"-12	53,1	41
BF2116-16RAX	BF21.2012.1616	16	1"	1.5/16"-12	53,0	41

MATERIAL: Carbon Steel

FINISH: Chromium-(VI) Free plating / ROHS compliant

Suitable to be used on medium and high pressure braided hoses:

FORZA UNO R1AT/1SN; FORZA UNO "SHARK SKIN" R1AT/1SN; FORZA UNO TROPIC R1AT/1SN; FORZA DUE R2AT/2SN; FORZA DUE "SHARK SKIN" R2AT/2SN; FORZA DUE TROPIC R2AT/2SN; BALPAC PREMIUM R16/2SC; BALPAC PREMIUM "SHARK SKIN" R16/2SC; BALPAC PREMIUM TROPIC R16/2SC; IMPACTUS 5K; IMPACTUS 6K; BALPAC 3000 R17/1SC; BALPAC 3000 "SHARK SKIN" R17/1SC; 2-MAX JACK; BALWASH 1W; BALWASH 2W



SAE 90° Elbow Swivel O-ring Boss Male - RAX90

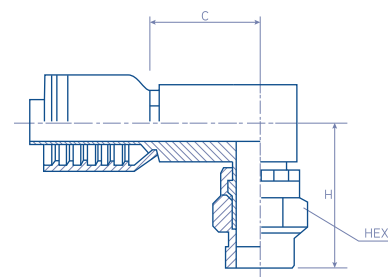

BF21.2092.

ISO 12151-5 / ISO 8434-2 / SAE J512 / SAE J513

REFERENCE	#	hose		thread	dimensions		
		dash	inch		C - Cut Off	H	HEX
BF2106-06RA90X	BF21.2092.0606	06	3/8"	9/16"-18	38,0	50,0	43,3
BF2106-08RA90X	BF21.2092.0608	06	3/8"	3/4"-16	40,0	47,0	45,0
BF2108-08RA90X	BF21.2092.0808	08	1/2"	3/4"-16	43,0	47,0	45,0
BF2108-10RA90X	BF21.2092.0810	08	1/2"	7/8"-14	43,0	49,0	39,5
BF2112-12RA90X	BF21.2092.1212	12	3/4"	1.1/16"-12	48,0	58,0	51,7

MATERIAL: Carbon Steel

FINISH: Chromium-(VI) Free plating /
ROHS compliant

Suitable to be used on medium and high pressure braided hoses:

FORZA UNO R1AT/1SN; FORZA UNO "SHARK SKIN" R1AT/1SN; FORZA UNO TROPIC R1AT/1SN; FORZA DUE R2AT/2SN; FORZA DUE "SHARK SKIN" R2AT/2SN; FORZA DUE TROPIC R2AT/2SN; BALPAC PREMIUM R16/2SC; BALPAC PREMIUM "SHARK SKIN" R16/2SC; BALPAC PREMIUM TROPIC R16/2SC; IMPACTUS 5K; IMPACTUS 6K; BALPAC 3000 R17/1SC; BALPAC 3000 "SHARK SKIN" R17/1SC; 2-MAX JACK; BALWASH 1W; BALWASH 2W

Female ORFS Swivel - OFT

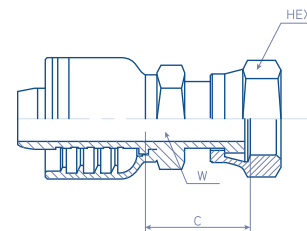

BF21.44H4.

ISO 12151-1 / ISO 8434-3 / SAE J1453

REFERENCE	#	hose		thread	dimensions		
		dash	inch		C - Cut Off	W	HEX
BF2104-04OFT	BF21.44H4.0404	04	1/4"	9/16"-18	30,2	14	17
BF2104-06OFT	BF21.44H4.0406	04	1/4"	1.1/16"-18	32,4	17	22
BF2106-04OFT	BF21.44H4.0604	06	3/8"	9/16"-18	29,3	17	17
BF2106-06OFT	BF21.44H4.0606	06	3/8"	11/16"-18	32,3	17	22
BF2106-08OFT	BF21.44H4.0608	06	3/8"	1.3/16"-16	35,3	19	24
BF2108-06OFT	BF21.44H4.0806	08	1/2"	1.1/16"-18	34,7	19	22
BF2108-08OFT	BF21.44H4.0808	08	1/2"	1.3/16"-16	36,7	19	24
BF2108-10OFT	BF21.44H4.0810	08	1/2"	1"-14	42,7	24	30
BF2108-12OFT	BF21.44H4.0812	08	1/2"	1.3/16"-12	45,5	30	36
BF2110-08OFT	BF21.44H4.1008	10	5/8"	1.3/16"-16	39,8	22	24
BF2110-10OFT	BF21.44H4.1010	10	5/8"	1"-14	43,8	24	30
BF2110-12OFT	BF21.44H4.1012	10	5/8"	1.3/16"-12	47,3	28	36
BF2112-10OFT	BF21.44H4.1210	12	3/4"	1"-14	44,8	28	30
BF2112-12OFT	BF21.44H4.1212	12	3/4"	1.3/16"-12	46,8	30	36
BF2112-16OFT	BF21.44H4.1216	12	3/4"	1.7/16"-12	51,3	35	41
BF2116-12OFT	BF21.44H4.1612	16	1"	1.3/16"-12	49,2	35	36
BF2116-16OFT	BF21.44H4.1616	16	1"	1.7/16"-12	51,3	35	41

MATERIAL: Carbon Steel

FINISH: Chromium-(VI) Free plating /
ROHS compliant

Suitable to be used on medium and high pressure braided hoses:

FORZA UNO R1AT/1SN; FORZA UNO "SHARK SKIN" R1AT/1SN; FORZA UNO TROPIC R1AT/1SN; FORZA DUE R2AT/2SN; FORZA DUE "SHARK SKIN" R2AT/2SN; FORZA DUE TROPIC R2AT/2SN; BALPAC PREMIUM R16/2SC; BALPAC PREMIUM "SHARK SKIN" R16/2SC; BALPAC PREMIUM TROPIC R16/2SC; IMPACTUS 5K; IMPACTUS 6K; BALPAC 3000 R17/1SC; BALPAC 3000 "SHARK SKIN" R17/1SC; 2-MAX JACK; BALWASH 1W; BALWASH 2W



Female ORFS Swivel 45° Elbow- OFT45

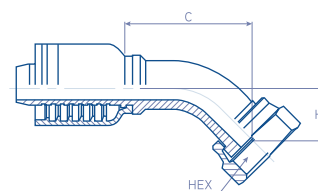

BF21.4444.

ISO 12151-1 / ISO 8434-3 / SAE J1453

REFERENCE	#	hose		thread	dimensions		
		dash	inch		C - Cut Off	H	HEX
BF2104-04OF45	BF21.4444.0404	04	1/4"	9/16"-18	35	10	17
BF2104-06OF45	BF21.4444.0406	04	1/4"	11/16"-18	35	11	22
BF2106-04OF45	BF21.4444.0604	06	3/8"	9/16"-18	40	15	17
BF2106-06OF45	BF21.4444.0606	06	3/8"	11/16"-18	40	13,5	22
BF2106-08OF45	BF21.4444.0608	06	3/8"	13/16"-16	40	15	24
BF2108-06OF45	BF21.4444.0806	08	1/2"	11/16"-18	46	18,5	24
BF2108-08OF45	BF21.4444.0808	08	1/2"	13/16"-16	43	15	24
BF2108-10OF45	BF21.4444.0810	08	1/2"	1"-14	45	16	30
BF2108-12OF45	BF21.4444.0812	08	1/2"	1.3/16"-12	54	21	36
BF2110-10OF45	BF21.4444.1010	10	5/8"	1"-14	50	18	30
BF2110-12OF45	BF21.4444.1012	10	5/8"	1.3/16"-12	55	21	36
BF2112-12OF45	BF21.4444.1212	12	3/4"	1.3/16"-12	65	21	36
BF2112-16OF45	BF21.4444.1216	12	3/4"	1.7/16"-12	74	25	41
BF2116-12OF45	BF21.4444.1612	16	1"	1.3/16"-12	75	25	36
BF2116-16OF45	BF21.4444.1616	16	1"	1.7/16"-12	76	25	41

MATERIAL: Carbon Steel

FINISH: Chromium-(VI) Free plating /
ROHS compliant

Suitable to be used on medium and high pressure braided hoses:

FORZA UNO R1AT/1SN; FORZA UNO "SHARK SKIN" R1AT/1SN; FORZA UNO TROPIC R1AT/1SN; FORZA DUE R2AT/2SN; FORZA DUE "SHARK SKIN" R2AT/2SN; FORZA DUE TROPIC R2AT/2SN; BALPAC PREMIUM R16/2SC; BALPAC PREMIUM "SHARK SKIN" R16/2SC; BALPAC PREMIUM TROPIC R16/2SC; IMPACTUS 5K; IMPACTUS 6K; BALPAC 3000 R17/1SC; BALPAC 3000 "SHARK SKIN" R17/1SC; 2-MAX JACK; BALWASH 1W; BALWASH 2W

Female ORFS Swivel 90° Elbow - OFT90

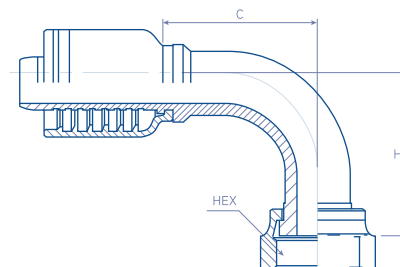

BF21.4494.

ISO 12151-1 / ISO 8434-3 / SAE J1453

REFERENCE	#	hose		thread	dimensions		
		dash	inch		C - Cut Off	H	HEX
BF2104-04OF90	BF21.4494.0404	04	1/4"	9/16"-18	33,0	21,0	17
BF2104-06OF90	BF21.4494.0406	04	1/4"	11/16"-18	33,0	23,0	22
BF2106-04OF90	BF21.4494.0604	06	1/4"	9/16"-18	34,5	27,0	17
BF2106-06OF90	BF21.4494.0606	06	3/8"	11/16"-18	34,5	29,0	22
BF2106-08OF90	BF21.4494.0608	06	3/8"	13/16"-16	37,0	30,0	24
BF2108-06OF90	BF21.4494.0806	08	1/2"	11/16"-18	39,5	34,0	22
BF2108-08OF90	BF21.4494.0808	08	1/2"	13/16"-16	39,5	35,0	24
BF2108-10OF90	BF21.4494.0810	08	1/2"	1"-14	39,5	36,5	30
BF2108-12OF90	BF21.4494.0812	08	1/2"	1.3/16"-12	42,0	45,0	36
BF2110-08OF90	BF21.4494.1008	10	5/8"	13/16"-16	45,0	30,0	24
BF2110-10OF90	BF21.4494.1010	10	5/8"	1"-14	54,0	40,0	30
BF2110-12OF90	BF21.4494.1012	10	5/8"	1.3/16"-12	54,0	48,0	36
BF2112-12OF90	BF21.4494.1212	12	3/4"	1.3/16"-12	57,0	48,0	36
BF2112-16OF90	BF21.4494.1216	12	3/4"	1.7/16"-12	57,0	56,0	41
BF2116-12OF90	BF21.4494.1612	16	1"	1.3/16"-12	65,0	58,0	36
BF2116-16OF90	BF21.4494.1616	16	1"	1.7/16"-12	70,0	60,0	41

MATERIAL: Carbon Steel

FINISH: Chromium-(VI) Free plating /
ROHS compliant

Suitable to be used on medium and high pressure braided hoses:

FORZA UNO R1AT/1SN; FORZA UNO "SHARK SKIN" R1AT/1SN; FORZA UNO TROPIC R1AT/1SN; FORZA DUE R2AT/2SN; FORZA DUE "SHARK SKIN" R2AT/2SN; FORZA DUE TROPIC R2AT/2SN; BALPAC PREMIUM R16/2SC; BALPAC PREMIUM "SHARK SKIN" R16/2SC; BALPAC PREMIUM TROPIC R16/2SC; IMPACTUS 5K; IMPACTUS 6K; BALPAC 3000 R17/1SC; BALPAC 3000 "SHARK SKIN" R17/1SC; 2-MAX JACK; BALWASH 1W; BALWASH 2W



Female ORFS Swivel 90° Long Elbow - OFT90

BF21.4494-L.

ISO 12151-1 / ISO 8434-3 / SAE J1453

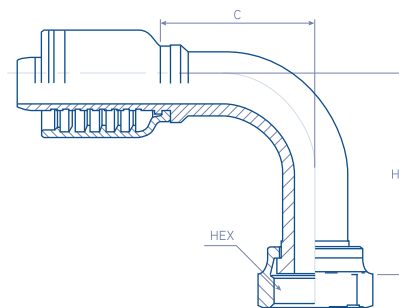

REFERENCE	#	hose		thread	dimensions		
		dash	inch		C - Cut Off	H	HEX
BF2104-04OF90L	BF21.4494.0404L	04	1/4"	9/16"-18	21,0	46,0	17
BF2106-06OF90L	BF21.4494.0606L	06	3/8"	11/16"-18	35,5	54,0	22
BF2106-08OF90L	BF21.4494.0608L	06	3/8"	13/16"-16	37,0	64,0	24
BF2108-08OF90L	BF21.4494.0808L	08	1/2"	13/16"-16	40,0	64,0	24
BF2110-10OF90L	BF21.4494.1010L	10	5/8"	1"-14	53,5	70,0	30
BF2112-12OF90L	BF21.4494.1212L	12	3/4"	1.3/16"-12	57,0	96,0	36
BF2116-16OF90L	BF21.4494.1616L	16	1"	1.7/16"-12	70,3	114,0	41

MATERIAL: Carbon Steel

FINISH: Chromium-(VI) Free plating /
ROHS compliant

Suitable to be used on medium and high pressure braided hoses:

FORZA UNO R1AT/1SN; FORZA UNO "SHARK SKIN" R1AT/1SN; FORZA UNO TROPIC R1AT/1SN; FORZA DUE R2AT/2SN; FORZA DUE "SHARK SKIN" R2AT/2SN; FORZA DUE TROPIC R2AT/2SN; BALPAC PREMIUM R16/2SC; BALPAC PREMIUM "SHARK SKIN" R16/2SC; BALPAC PREMIUM TROPIC R16/2SC; IMPACTUS 5K; IMPACTUS 6K; BALPAC 3000 R17/1SC; BALPAC 3000 "SHARK SKIN" R17/1SC; 2-MAX JACK; BALWASH 1W; BALWASH 2W

Male ORFS - OFTM

BF21.4000.

ISO 12151-1 / ISO 8434-3 / SAE J1453

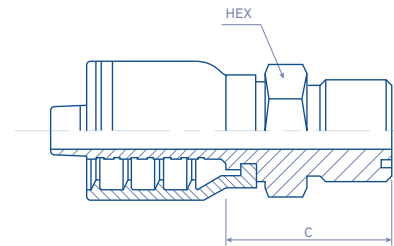

REFERENCE	#	hose		thread	dimensions	
		dash	inch		C - Cut Off	HEX
BF2104-04OFTM	BF21.4000.0404	04	1/4"	9/16"-18	24,9	17
BF2104-06OFTM	BF21.4000.0406	04	1/4"	1.1/16"-18	26,2	19
BF2106-06OFTM	BF21.4000.0606	06	3/8"	11/16"-18	26,0	19
BF2106-08OFTM	BF21.4000.0608	06	3/8"	1.3/16"-16	27,5	22
BF2108-08OFTM	BF21.4000.0808	08	1/2"	13/16"-16	29,7	22
BF2108-10OFTM	BF21.4000.0810	08	1/2"	1"-14	34,0	27
BF2108-12OFTM	BF21.4000.0812	08	1/2"	1.3/16"-12	38,2	32
BF2110-10OFTM	BF21.4000.1010	10	5/8"	1"-14	36,0	27
BF2110-12OFTM	BF21.4000.1012	10	5/8"	1.3/16"-12	38,5	32
BF2112-12OFTM	BF21.4000.1212	12	3/4"	1.3/16"-12	37,7	32
BF2112-16OFTM	BF21.4000.1216	12	3/4"	1.7/16"-12	42,2	41
BF2116-16OFTM	BF21.4000.1616	16	1"	1.7/16"-12	42,7	41

MATERIAL: Carbon Steel

FINISH: Chromium-(VI) Free plating /
ROHS compliant

Suitable to be used on medium and high pressure braided hoses:

FORZA UNO R1AT/1SN; FORZA UNO "SHARK SKIN" R1AT/1SN; FORZA UNO TROPIC R1AT/1SN; FORZA DUE R2AT/2SN; FORZA DUE "SHARK SKIN" R2AT/2SN; FORZA DUE TROPIC R2AT/2SN; BALPAC PREMIUM R16/2SC; BALPAC PREMIUM "SHARK SKIN" R16/2SC; BALPAC PREMIUM TROPIC R16/2SC; IMPACTUS 5K; IMPACTUS 6K; BALPAC 3000 R17/1SC; BALPAC 3000 "SHARK SKIN" R17/1SC; 2-MAX JACK; BALWASH 1W; BALWASH 2W



Straight SAE 3000 PSI Code 61 Flange - PA

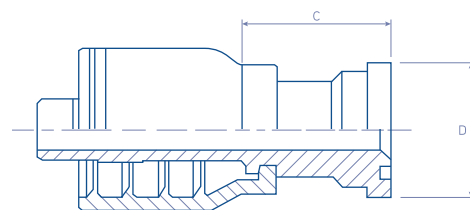

BF21.7013.

SAE J516 (CODE 61) / SAE J518 / ISO 12151-3

REFERENCE	#	hose		flange size	dimensions	
		dash	inch		C - Cut Off	D
BF2108-08PA	BF21.7013.0808	08	1/2"	1/2"	47,0	30,2
BF2108-12PA	BF21.7013.0812	08	1/2"	3/4"	48,0	38,1
BF2110-10PA	BF21.7013.1010	10	5/8"	5/8"	58,0	34,0
BF2110-12PA	BF21.7013.1012	10	5/8"	3/4"	44,0	38,1
BF2112-12PA	BF21.7013.1212	12	3/4"	3/4"	48,8	38,1
BF2112-16PA	BF21.7013.1216	12	3/4"	1"	52,0	44,5
BF2116-16PA	BF21.7013.1616	16	1"	1"	56,0	44,5

MATERIAL: Carbon Steel

FINISH: Chromium-(VI) Free plating /
ROHS compliant

Suitable to be used on medium and high pressure braided hoses:

FORZA UNO R1AT/1SN; FORZA UNO "SHARK SKIN" R1AT/1SN; FORZA UNO TROPIC R1AT/1SN; FORZA DUE R2AT/2SN; FORZA DUE "SHARK SKIN" R2AT/2SN; FORZA DUE TROPIC R2AT/2SN; BALPAC PREMIUM R16/2SC; BALPAC PREMIUM "SHARK SKIN" R16/2SC; BALPAC PREMIUM TROPIC R16/2SC; IMPACTUS 5K; IMPACTUS 6K; BALPAC 3000 R17/1SC; BALPAC 3000 "SHARK SKIN" R17/1SC; 2-MAX JACK; BALWASH 1W; BALWASH 2W

45° Elbow SAE 3000 PSI Code 61 Flange - PA45

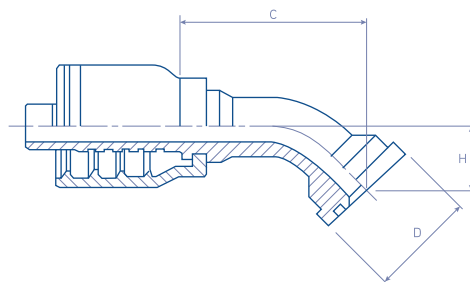

BF21.7043.

SAE J516 (CODE 61) / SAE J518 / ISO 12151-3

REFERENCE	#	hose		flange size	dimensions		
		dash	inch		C - Cut Off	H	D
BF2108-08PA45	BF21.7043.0808	08	1/2"	1/2"	57,0	23,0	30,2
BF2108-12PA45	BF21.7043.0812	08	1/2"	3/4"	63,0	30,0	38,1
BF2110-10PA45	BF21.7043.1010	10	5/8"	5/8"	68,0	27,0	34,0
BF2112-12PA45	BF21.7043.1212	12	3/4"	3/4"	69,0	28,0	38,1
BF2112-16PA45	BF21.7043.1216	12	3/4"	1"	77,0	32,0	44,5
BF2116-16PA45	BF21.7043.1616	16	1"	1"	79,0	31,0	44,5

MATERIAL: Carbon Steel

FINISH: Chromium-(VI) Free plating /
ROHS compliant

Suitable to be used on medium and high pressure braided hoses:

FORZA UNO R1AT/1SN; FORZA UNO "SHARK SKIN" R1AT/1SN; FORZA UNO TROPIC R1AT/1SN; FORZA DUE R2AT/2SN; FORZA DUE "SHARK SKIN" R2AT/2SN; FORZA DUE TROPIC R2AT/2SN; BALPAC PREMIUM R16/2SC; BALPAC PREMIUM "SHARK SKIN" R16/2SC; BALPAC PREMIUM TROPIC R16/2SC; IMPACTUS 5K; IMPACTUS 6K; BALPAC 3000 R17/1SC; BALPAC 3000 "SHARK SKIN" R17/1SC; 2-MAX JACK; BALWASH 1W; BALWASH 2W



90° Elbow SAE 3000 PSI Code 61 Flange - PA90

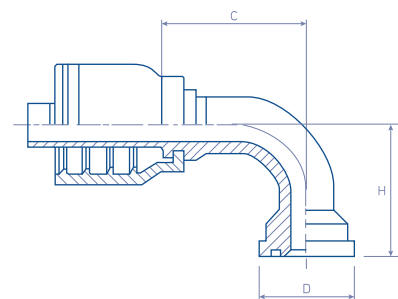

BF21.7093.

SAE J516 (CODE 61) / SAE J518 / ISO 12151-3

REFERENCE	#	hose		flange size	dimensions		
		dash	inch		C - Cut Off	H	D
BF2108-08PA90	BF21.7093.0808	08	1/2"	1/2"	48,0	41,0	30,2
BF2108-12PA90	BF21.7093.0812	08	1/2"	3/4"	50,0	48,0	38,1
BF2110-12PA90	BF21.7093.1012	10	5/8"	3/4"	55,0	55,0	38,1
BF2112-12PA90	BF21.7093.1212	12	3/4"	3/4"	60,0	60,0	38,1
BF2112-16PA90	BF21.7093.1216	12	3/4"	1"	65,0	60,0	44,5
BF2116-16PA90	BF21.7093.1616	16	1"	1"	73,0	61,0	44,5

MATERIAL: Carbon Steel

FINISH: Chromium-(VI) Free plating /
ROHS compliant

Suitable to be used on medium and high pressure braided hoses:

FORZA UNO R1AT/1SN; FORZA UNO "SHARK SKIN" R1AT/1SN; FORZA UNO TROPIC R1AT/1SN; FORZA DUE R2AT/2SN; FORZA DUE "SHARK SKIN" R2AT/2SN; FORZA DUE TROPIC R2AT/2SN; BALPAC PREMIUM R16/2SC; BALPAC PREMIUM "SHARK SKIN" R16/2SC; BALPAC PREMIUM TROPIC R16/2SC; IMPACTUS 5K; IMPACTUS 6K; BALPAC 3000 R17/1SC; BALPAC 3000 "SHARK SKIN" R17/1SC; 2-MAX JACK; BALWASH 1W; BALWASH 2W

Light 24° Metric Female - DLF

BF21.5013.

ISO 12151-2 / ISO 8434-1

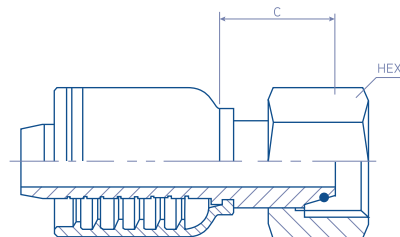

REFERENCE	#	hose		thread	dimensions		
		dash	inch		d	C - Cut Off	HEX
BF2104-12DLF	BF21.5013.0412	04	1/4"	M12X1.5	6	27,7	14
BF2104-14DLF	BF21.5013.0414	04	1/4"	M14X1.5	8	25,9	17
BF2104-16DLF	BF21.5013.0416	04	1/4"	M16X1.5	10	24,9	19
BF2104-18DLF	BF21.5013.0418	04	1/4"	M18X1.5	12	26,4	22
BF2106-16DLF	BF21.5013.0616	06	3/8"	M16X1.5	10	27,2	19
BF2106-18DLF	BF21.5013.0618	06	3/8"	M18X1.5	12	25,5	22
BF2106-22DLF	BF21.5013.0622	08	1/2"	M22X1.5	12	26,0	27
BF2108-22DLF	BF21.5013.0822	08	1/2"	M22X1.5	15	27,7	27
BF2108-26DLF	BF21.5013.0826	08	1/2"	M26X1.5	18	28,7	32
BF2110-26DLF	BF21.5013.1026	10	5/8"	M26X1.5	18	30,0	32
BF2112-30DLF	BF21.5013.1230	12	3/4"	M30X2.0	22	32,3	36
BF2116-36DLF	BF21.5013.1636	16	1"	M36X2.0	28	35,8	41

MATERIAL: Carbon Steel

FINISH: Chromium-(VI) Free plating / ROHS compliant

Suitable to be used on medium and high pressure braided hoses:

FORZA UNO R1AT/1SN; FORZA UNO "SHARK SKIN" R1AT/1SN; FORZA UNO TROPIC R1AT/1SN; FORZA DUE R2AT/2SN; FORZA DUE "SHARK SKIN" R2AT/2SN; FORZA DUE TROPIC R2AT/2SN; BALPAC PREMIUM R16/2SC; BALPAC PREMIUM "SHARK SKIN" R16/2SC; BALPAC PREMIUM TROPIC R16/2SC; IMPACTUS 5K; IMPACTUS 6K; BALPAC 3000 R17/1SC; BALPAC 3000 "SHARK SKIN" R17/1SC; 2-MAX JACK; BALWASH 1W; BALWASH 2W



Light 24° Metric 45° Elbow Female - DLF45

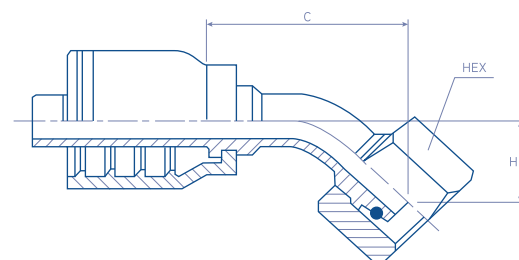

BF21.5043.

ISO 12151-2 / ISO 8434-1

REFERENCE	#	hose		thread	dimensions			
		dash	inch		d	C - Cut Off	H	HEX
BF2104-12DLF45	BF21.5043.0412	04	1/4"	M12X1.5	6	39	15	14
BF2104-14DLF45	BF21.5043.0414	04	1/4"	M14X1.5	8	42,7	17,7	17
BF2104-16DLF45	BF21.5043.0416	04	1/4"	M16X1.5	10	41,5	17,7	19
BF2104-18DLF45	BF21.5043.0418	04	1/4"	M18X1.5	12	42,0	18,3	22
BF2106-16DLF45	BF21.5043.0616	06	3/8"	M16X1.5	10	44,5	21	19
BF2106-18DLF45	BF21.5043.0618	06	3/8"	M18X1.5	12	42,5	19	22
BF2108-22DLF45	BF21.5043.0822	08	1/2"	M22X1.5	15	49,0	21,5	27
BF2108-26DLF45	BF21.5043.0826	08	1/2"	M26X1.5	18	60,0	25,0	32
BF2110-26DLF45	BF21.5043.1026	10	5/8"	M26X1.5	18	62,5	25	32
BF2112-30DLF45	BF21.5043.1230	12	3/4"	M30X2.0	22	76,0	29,5	36
BF2116-36DLF45	BF21.5043.1636	16	1"	M36X2.0	28	90,5	35	41

MATERIAL: Carbon Steel

FINISH: Chromium-(VI) Free plating /
ROHS compliant

Suitable to be used on medium and high pressure braided hoses:

FORZA UNO R1AT/1SN; FORZA UNO "SHARK SKIN" R1AT/1SN; FORZA UNO TROPIC R1AT/1SN; FORZA DUE R2AT/2SN; FORZA DUE "SHARK SKIN" R2AT/2SN; FORZA DUE TROPIC R2AT/2SN; BALPAC PREMIUM R16/2SC; BALPAC PREMIUM "SHARK SKIN" R16/2SC; BALPAC PREMIUM TROPIC R16/2SC; IMPACTUS 5K; IMPACTUS 6K; BALPAC 3000 R17/1SC; BALPAC 3000 "SHARK SKIN" R17/1SC; 2-MAX JACK; BALWASH 1W; BALWASH 2W

Light 24° Metric 90° Elbow Female - DLF90

BF21.5093.

ISO 12151-2 / ISO 8434-1

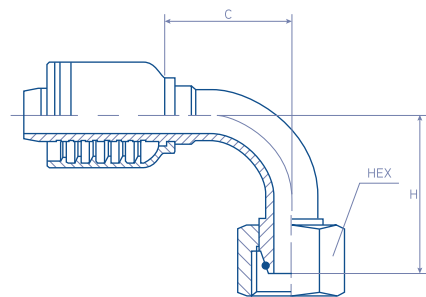

REFERENCE	#	hose		thread	dimensions			
		dash	inch		d	C - Cut Off	H	HEX
BF2104-12DLF90	BF21.5093.0412	04	1/4"	M12X1.5	6	30	30	14
BF2104-14DLF90	BF21.5093.0414	04	1/4"	M14X1.5	8	32	38	17
BF2104-16DLF90	BF21.5093.0416	04	1/4"	M16X1.5	10	31,7	38,0	19
BF2104-18DLF90	BF21.5093.0418	04	1/4"	M18X1.5	12	30,0	36,0	22
BF2106-16DLF90	BF21.5093.0616	06	3/8"	M16X1.5	10	35	36,0	19
BF2106-18DLF90	BF21.5093.0618	06	3/8"	M18X1.5	12	36	36,0	22
BF2106-22DLF90	BF21.5093.0622	06	3/8"	M22X1.5	15	34,2	36	27
BF2108-22DLF90	BF21.5093.0822	08	1/2"	M22X1.5	15	38	40,5	27
BF2108-26DLF90	BF21.5093.0826	08	1/2"	M26X1.5	18	48	51,5	32
BF2110-26DLF90	BF21.5093.1026	10	5/8"	M26X1.5	18	48	51,5	32
BF2112-30DLF90	BF21.5093.1230	12	3/4"	M30X2.0	22	54	54,5	36
BF2116-36DLF90	BF21.5093.1636	16	1"	M36X2.0	28	75	68,5	41

MATERIAL: Carbon Steel

FINISH: Chromium-(VI) Free plating / ROHS compliant

Suitable to be used on medium and high pressure braided hoses:

FORZA UNO R1AT/1SN; FORZA UNO "SHARK SKIN" R1AT/1SN; FORZA UNO TROPIC R1AT/1SN; FORZA DUE R2AT/2SN; FORZA DUE "SHARK SKIN" R2AT/2SN; FORZA DUE TROPIC R2AT/2SN; BALPAC PREMIUM R16/2SC; BALPAC PREMIUM "SHARK SKIN" R16/2SC; BALPAC PREMIUM TROPIC R16/2SC; IMPACTUS 5K; IMPACTUS 6K; BALPAC 3000 R17/1SC; BALPAC 3000 "SHARK SKIN" R17/1SC; 2-MAX JACK; BALWASH 1W; BALWASH 2W



Light 24° Metric Male - DLM

BF21.1000.

ISO 12151-2 / ISO 8434-1

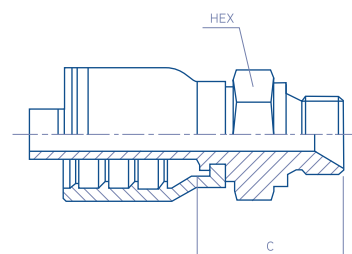

REFERENCE	#	hose		thread	dimensions		
		dash	inch		d	C - Cut Off	HEX
BF2104-12DLM	BF21.1000.0412	04	1/4"	M12X1.5	6	24,2	14
BF2104-14DLM	BF21.1000.0414	04	1/4"	M14X1.5	8	24,7	17
BF2104-16DLM	BF21.1000.0416	04	1/4"	M16X1.5	10	25,7	17
BF2104-18DLM	BF21.1000.0418	04	1/4"	M18X1.5	12	26,7	19
BF2106-16DLM	BF21.1000.0616	06	3/8"	M16X1.5	10	23,7	17
BF2106-18DLM	BF21.1000.0618	06	3/8"	M18X1.5	12	24,7	19
BF2106-22DLM	BF21.1000.0622	06	3/8"	M22X1.5	15	27,7	24
BF2108-18DLM	BF21.1000.0818	08	1/2"	M18X1.5	12	26,5	19
BF2108-22DLM	BF21.1000.0822	08	1/2"	M22X1.5	15	29,5	24
BF2110-26DLM	BF21.1000.1026	10	5/8"	M26X1.5	18	32,0	27
BF2110-30DLM	BF21.1000.1030	10	5/8"	M30X2.0	22	36,0	32
BF2112-30DLM	BF21.1000.1230	12	3/4"	M30X2.0	22	35,3	32
BF2116-36DLM	BF21.1000.1636	16	1"	M36X2.0	28	38,2	41

MATERIAL: Carbon Steel

FINISH: Chromium-(VI) Free plating /
ROHS compliant

Suitable to be used on medium and high pressure braided hoses:

FORZA UNO R1AT/1SN; FORZA UNO "SHARK SKIN" R1AT/1SN; FORZA UNO TROPIC R1AT/1SN; FORZA DUE R2AT/2SN; FORZA DUE "SHARK SKIN" R2AT/2SN; FORZA DUE TROPIC R2AT/2SN; BALPAC PREMIUM R16/2SC; BALPAC PREMIUM "SHARK SKIN" R16/2SC; BALPAC PREMIUM TROPIC R16/2SC; IMPACTUS 5K; IMPACTUS 6K; BALPAC 3000 R17/1SC; BALPAC 3000 "SHARK SKIN" R17/1SC; 2-MAX JACK; BALWASH 1W; BALWASH 2W

Heavy 24° Metric Female - DHF

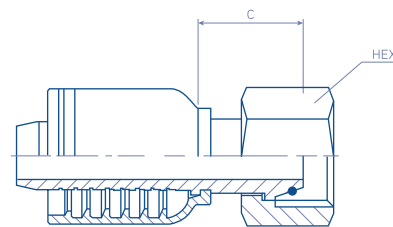

BF21.5113.

ISO 12151-2 / ISO 8434-1

REFERENCE	#	hose		thread	dimensions		
		dash	inch		d	C - Cut Off	HEX
BF2104-16DHF	BF21.5113.0416	04	1/4"	M16X1.5	8	27,0	19
BF2104-18DHF	BF21.5113.0418	04	1/4"	M18X1.5	10	27,5	22
BF2106-18DHF	BF21.5113.0618	06	3/8"	M18X1.5	10	25,5	22
BF2106-20DHF	BF21.5113.0620	06	3/8"	M20X1.5	12	25,0	24
BF2106-22DHF	BF21.5113.0622	06	3/8"	M22X1.5	14	29,5	27
BF2108-24DHF	BF21.5113.0824	08	1/2"	M24X1.5	16	31,0	30

MATERIAL: Carbon Steel

FINISH: Chromium-(VI) Free plating /
ROHS compliant

Suitable to be used on medium and high pressure braided hoses:

FORZA UNO R1AT/1SN; FORZA UNO "SHARK SKIN" R1AT/1SN; FORZA UNO TROPIC R1AT/1SN; FORZA DUE R2AT/2SN; FORZA DUE "SHARK SKIN" R2AT/2SN; FORZA DUE TROPIC R2AT/2SN; BALPAC PREMIUM R16/2SC; BALPAC PREMIUM "SHARK SKIN" R16/2SC; BALPAC PREMIUM TROPIC R16/2SC; IMPACTUS 5K; IMPACTUS 6K; BALPAC 3000 R17/1SC; BALPAC 3000 "SHARK SKIN" R17/1SC; 2-MAX JACK; BALWASH 1W; BALWASH 2W



Heavy 24° Metric 45° Elbow Female - DHF45

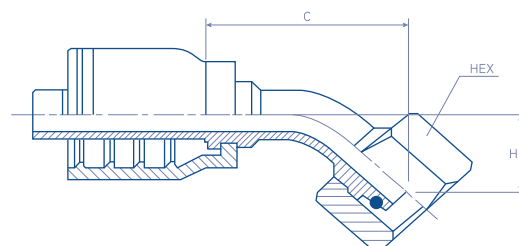

BF21.5143.

ISO 12151-2 / ISO 8434-1

REFERENCE	#	hose		thread	dimensions			
		dash	inch		d	C - Cut Off	H	HEX
BF2104-16DHF45	BF21.5143.0416	04	1/4"	M16X1.5	8	36,5	17,0	19
BF2104-18DHF45	BF21.5143.0418	04	1/4"	M18X1.5	10	40,5	16,7	22
BF2106-20DHF45	BF21.5143.0620	06	3/8"	M20X1.5	12	42,0	18,4	24
BF2106-22DHF45	BF21.5143.0622	06	3/8"	M22X1.5	14	42,4	18,7	27
BF2108-24DHF45	BF21.5143.0824	08	1/2"	M24X1.5	16	49,9	21,0	30

MATERIAL: Carbon Steel

FINISH: Chromium-(VI) Free plating /
ROHS compliant

Suitable to be used on medium and high pressure braided hoses:

FORZA UNO R1AT/1SN; FORZA UNO "SHARK SKIN" R1AT/1SN; FORZA UNO TROPIC R1AT/1SN; FORZA DUE R2AT/2SN; FORZA DUE "SHARK SKIN" R2AT/2SN; FORZA DUE TROPIC R2AT/2SN; BALPAC PREMIUM R16/2SC; BALPAC PREMIUM "SHARK SKIN" R16/2SC; BALPAC PREMIUM TROPIC R16/2SC; IMPACTUS 5K; IMPACTUS 6K; BALPAC 3000 R17/1SC; BALPAC 3000 "SHARK SKIN" R17/1SC; 2-MAX JACK; BALWASH 1W; BALWASH 2W

Heavy 24° Metric 90° Elbow Female - DHF90

BF21.5193.

ISO 12151-2 / ISO 8434-1

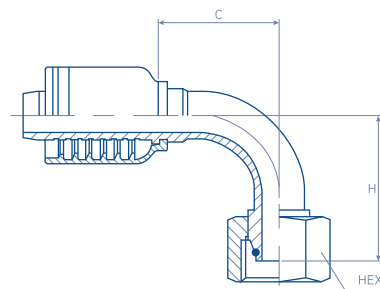

REFERENCE	#	hose		thread	dimensions			
		dash	inch		d	C - Cut Off	H	HEX
BF2104-16DHF90	BF21.5193.0416	04	1/4"	M16X1.5	8	28,2	32,0	19
BF2104-18DHF90	BF21.5193.0418	04	1/4"	M18X1.5	10	31,7	32,0	22
BF2106-18DHF90	BF21.5193.0618	06	3/8"	M18X1.5	10	33,0	33,0	22
BF2106-20DHF90	BF21.5193.0620	06	3/8"	M20X1.5	12	34,2	36,5	24
BF2106-22DHF90	BF21.5193.0622	06	3/8"	M22X1.5	14	34,2	37,0	27
BF2108-24DHF90	BF21.5193.0824	08	1/2"	M24X1.5	16	41,0	43,0	30

MATERIAL: Carbon Steel

FINISH: Chromium-(VI) Free plating /
ROHS compliant

Suitable to be used on medium and high pressure braided hoses:

FORZA UNO R1AT/1SN; FORZA UNO "SHARK SKIN" R1AT/1SN; FORZA UNO TROPIC R1AT/1SN; FORZA DUE R2AT/2SN; FORZA DUE "SHARK SKIN" R2AT/2SN; FORZA DUE TROPIC R2AT/2SN; BALPAC PREMIUM R16/2SC; BALPAC PREMIUM "SHARK SKIN" R16/2SC; BALPAC PREMIUM TROPIC R16/2SC; IMPACTUS 5K; IMPACTUS 6K; BALPAC 3000 R17/1SC; BALPAC 3000 "SHARK SKIN" R17/1SC; 2-MAX JACK; BALWASH 1W; BALWASH 2W



Heavy 24° Metric Male - DHM

BF21.1100.

ISO 12151-2 / ISO 8434-1

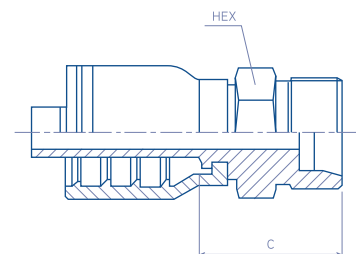

REFERENCE	#	hose		thread	dimensions		
		dash	inch		d	C - Cut Off	HEX
BF2104-14DHM	BF21.1100.0414	04	1/4"	M14X1.5	6	26,7	17
BF2104-16DHM	BF21.1100.0416	04	1/4"	M16X1.5	8	26,7	17
BF2104-18DHM	BF21.1100.0418	04	1/4"	M18X1.5	10	27,7	19
BF2104-20DHM	BF21.1100.0420	04	1/4"	M20X1.5	12	29,2	22
BF2106-18DHM	BF21.1100.0618	06	3/8"	M18X1.5	10	25,7	19
BF2106-20DHM	BF21.1100.0620	06	3/8"	M20X1.5	12	27,2	22
BF2106-22DHM	BF21.1100.0622	06	3/8"	M22X1.5	14	29,7	24
BF2106-24DHM	BF21.1100.0624	06	3/8"	M24X1.5	16	31,2	27
BF2108-24DHM	BF21.1100.0824	08	1/2"	M24X1.5	16	33,0	27
BF2110-30DHM	BF21.1100.1030	10	5/8"	M30X2.0	20	38,0	32

MATERIAL: Carbon Steel

FINISH: Chromium-(VI) Free plating /
ROHS compliant

Suitable to be used on medium and high pressure braided hoses:

FORZA UNO R1AT/1SN; FORZA UNO "SHARK SKIN" R1AT/1SN; FORZA UNO TROPIC R1AT/1SN; FORZA DUE R2AT/2SN; FORZA DUE "SHARK SKIN" R2AT/2SN; FORZA DUE TROPIC R2AT/2SN; BALPAC PREMIUM R16/2SC; BALPAC PREMIUM "SHARK SKIN" R16/2SC; BALPAC PREMIUM TROPIC R16/2SC; IMPACTUS 5K; IMPACTUS 6K; BALPAC 3000 R17/1SC; BALPAC 3000 "SHARK SKIN" R17/1SC; 2-MAX JACK; BALWASH 1W; BALWASH 2W

JIS 30° Female Swivel - FX-KOMA

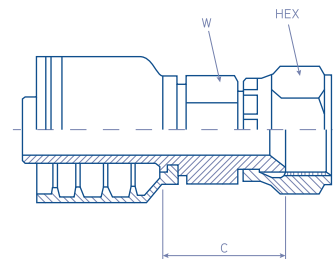

BF21.5911.

JIS B 8363

REFERENCE	#	hose		thread	dimensions		
		dash	inch		C - Cut Off	W	HEX
BF2104-14FX-KOMA	BF21.5911.0414	04	1/4"	M14X1.5	24,2	19	19
BF2106-16FX-KOMA	BF21.5911.0616	06	3/8"	M16X1.5	23,2	19	22
BF2106-18FX-KOMA	BF21.5911.0618	06	3/8"	M18X1.5	24,2	19	24
BF2106-20FX-KOMA	BF21.5911.0620	06	3/8"	M20X1.5	25,2	19	27
BF2108-22FX-KOMA	BF21.5911.0822	08	1/2"	M22X1.5	28,0	22	27
BF2110-24FX-KOMA	BF21.5911.1024	10	5/8"	M24X1.5	30,5	24	32
BF2112-30FX-KOMA	BF21.5911.1230	12	3/4"	M30X2.0	32,8	30	36
BF2112-33FX-KOMA	BF21.5911.1233	12	3/4"	M33X2.0	33,8	32	41
BF2112-36FX-KOMA	BF21.5911.1236	12	3/4"	M36X2.0	36,3	41	46
BF2116-33FX-KOMA	BF21.5911.1633	16	1"	M33X2.0	33,7	32	41
BF2116-36FX-KOMA	BF21.5911.1636	16	1"	M36X2.0	26,2	41	46

MATERIAL: Carbon Steel

FINISH: Chromium-(VI) Free plating / ROHS compliant

Suitable to be used on medium and high pressure braided hoses:

FORZA UNO R1AT/1SN; FORZA UNO "SHARK SKIN" R1AT/1SN; FORZA UNO TROPIC R1AT/1SN; FORZA DUE R2AT/2SN; FORZA DUE "SHARK SKIN" R2AT/2SN; FORZA DUE TROPIC R2AT/2SN; BALPAC PREMIUM R16/2SC; BALPAC PREMIUM "SHARK SKIN" R16/2SC; BALPAC PREMIUM TROPIC R16/2SC; IMPACTUS 5K; IMPACTUS 6K; BALPAC 3000 R17/1SC; BALPAC 3000 "SHARK SKIN" R17/1SC; 2-MAX JACK; BALWASH 1W; BALWASH 2W



Female JIS 30° Swivel 90° Elbow - FX-KOMA90

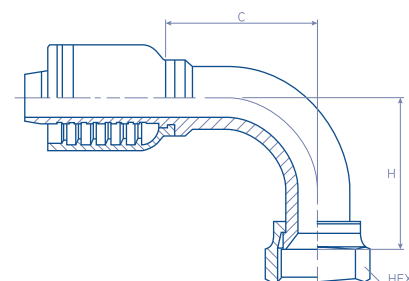

BF21.5991.

JIS B 8363

REFERENCE	#	hose		thread	dimensions		
		dash	inch		C - Cut Off	H	HEX
BF2104-14FX-KOMA90	BF21.5991.0414	04	1/4"	M14X1.5	25,0	28	19
BF2106-18FX-KOMA90	BF21.5991.0618	06	3/8"	M18X1.5	31,0	37	24
BF2108-22FX-KOMA90	BF21.5991.0822	08	1/2"	M22X1.5	41,0	48	27
BF2110-24FX-KOMA90	BF21.5991.1024	10	5/8"	M24X1.5	42,0	50	32
BF2112-30FX-KOMA90	BF21.5991.1230	12	3/4"	M30X2.0	48,5	57	36

MATERIAL: Carbon Steel

FINISH: Chromium-(VI) Free plating /
ROHS compliant

Suitable to be used on medium and high pressure braided hoses:

FORZA UNO R1AT/1SN; FORZA UNO "SHARK SKIN" R1AT/1SN; FORZA UNO TROPIC R1AT/1SN; FORZA DUE R2AT/2SN; FORZA DUE "SHARK SKIN" R2AT/2SN; FORZA DUE TROPIC R2AT/2SN; BALPAC PREMIUM R16/2SC; BALPAC PREMIUM "SHARK SKIN" R16/2SC; BALPAC PREMIUM TROPIC R16/2SC; IMPACTUS 5K; IMPACTUS 6K; BALPAC 3000 R17/1SC; BALPAC 3000 "SHARK SKIN" R17/1SC; 2-MAX JACK; BALWASH 1W; BALWASH 2W

JIS 30° Female Swivel - JIS

BF21.3712.

JIS B 8363

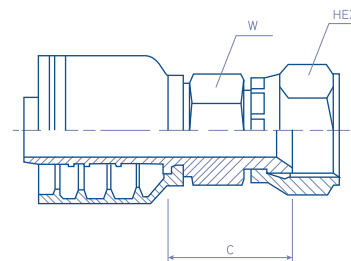

REFERENCE	#	hose		thread	dimensions		
		dash	inch		C - Cut Off	W	HEX
BF2104-04JIS	BF21.3712.0404	04	1/4"	1/4" - 19	23,0	19	19
BF2106-06JIS	BF21.3712.0606	06	3/8"	3/8" - 19	23,0	22	22
BF2108-08JIS	BF21.3712.0808	08	1/2"	1/2" - 14	27,7	27	27
BF2112-12JIS	BF21.3712.1212	12	3/4"	3/4" - 14	31,4	32	32
BF2116-16JIS	BF21.3712.1616	16	1"	1" - 11	32,0	41	41

MATERIAL: Carbon Steel

FINISH: Chromium-(VI) Free plating / ROHS compliant

Suitable to be used on medium and high pressure braided hoses:

FORZA UNO R1AT/1SN; FORZA UNO "SHARK SKIN" R1AT/1SN; FORZA UNO TROPIC R1AT/1SN; FORZA DUE R2AT/2SN; FORZA DUE "SHARK SKIN" R2AT/2SN; FORZA DUE TROPIC R2AT/2SN; BALPAC PREMIUM R16/2SC; BALPAC PREMIUM "SHARK SKIN" R16/2SC; BALPAC PREMIUM TROPIC R16/2SC; IMPACTUS 5K; IMPACTUS 6K; BALPAC 3000 R17/1SC; BALPAC 3000 "SHARK SKIN" R17/1SC; 2-MAX JACK; BALWASH 1W; BALWASH 2W



BSP 60° Swivel Female - BSPXF

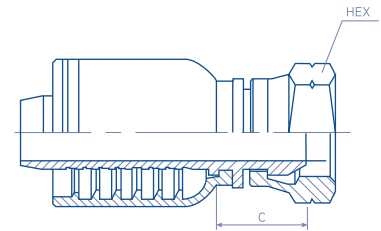

BF21.3012.

ISO 12151-6 / ISO 8434-6

REFERENCE	#	hose		thread	dimensions	
		dash	inch		C - Cut Off	HEX
BF2104-02BSPXF	BF21.3012.0402	04	1/4"	1/8"-28	17,7	14
BF2104-04BSPXF	BF21.3012.0404	04	1/4"	1/4"-19	19,9	19
BF2104-06BSPXF	BF21.3012.0406	04	1/4"	3/8"-19	20,7	22
BF2104-08BSPXF	BF21.3012.0408	04	1/4"	1/2"-14	22,7	27
BF2106-06BSPXF	BF21.3012.0606	06	3/8"	3/8"-19	19,5	22
BF2106-08BSPXF	BF21.3012.0608	06	3/8"	1/2"-14	20,7	27
BF2108-08BSPXF	BF21.3012.0808	08	1/2"	1/2"-14	22,7	27
BF2108-10BSPXF	BF21.3012.0810	08	1/2"	5/8"-14	23,0	30
BF2110-10BSPXF	BF21.3012.1010	10	5/8"	5/8"-14	25,0	30
BF2110-12BSPXF	BF21.3012.1012	10	5/8"	3/4"-14	25,5	32
BF2112-12BSPXF	BF21.3012.1212	12	3/4"	3/4"-14	24,9	32
BF2112-16BSPXF	BF21.3012.1216	12	3/4"	1"-11	26,8	38
BF2116-16BSPXF	BF21.3012.1616	16	1"	1"-11	26,8	38

MATERIAL: Carbon Steel

FINISH: Chromium-(VI) Free plating /
ROHS compliant

Suitable to be used on medium and high pressure braided hoses:

FORZA UNO R1AT/1SN; FORZA UNO "SHARK SKIN" R1AT/1SN; FORZA UNO TROPIC R1AT/1SN; FORZA DUE R2AT/2SN; FORZA DUE "SHARK SKIN" R2AT/2SN; FORZA DUE TROPIC R2AT/2SN; BALPAC PREMIUM R16/2SC; BALPAC PREMIUM "SHARK SKIN" R16/2SC; BALPAC PREMIUM TROPIC R16/2SC; IMPACTUS 5K; IMPACTUS 6K; BALPAC 3000 R17/1SC; BALPAC 3000 "SHARK SKIN" R17/1SC; 2-MAX JACK; BALWASH 1W; BALWASH 2W

BSP 60° Swivel 45° Elbow Female - BSPXF45

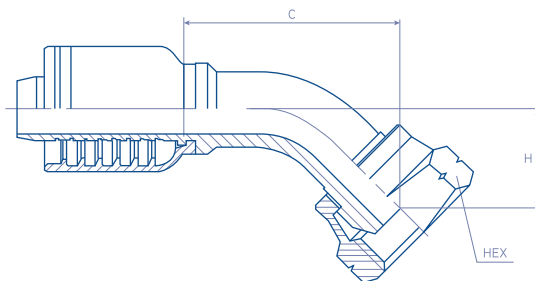

BF21.3042.

ISO 12151-6 / ISO 8434-6

REFERENCE	#	hose		thread	dimensions		
		dash	inch		C - Cut Off	H	HEX
BF2104-02BSPXF45	BF21.3042.0402	04	1/4"	1/8"-28	33,0	14,0	14
BF2104-04BSPXF45	BF21.3042.0404	04	1/4"	1/4"-19	41,1	15,0	19
BF2104-06BSPXF45	BF21.3042.0406	04	1/4"	3/8"-19	34,2	15,0	22
BF2106-06BSPXF45	BF21.3042.0606	06	3/8"	3/8"-19	40,0	17,5	22
BF2106-08BSPXF45	BF21.3042.0608	06	3/8"	1/2"-14	38,6	17,0	27
BF2108-08BSPXF45	BF21.3042.0808	08	1/2"	1/2"-14	46,0	19,0	27
BF2108-10BSPXF45	BF21.3042.0810	08	1/2"	5/8"-14	56,0	23,0	27
BF2110-10BSPXF45	BF21.3042.1010	10	5/8"	5/8"-14	60,5	23,3	27
BF2110-12BSPXF45	BF21.3042.1012	10	5/8"	3/4"-14	63,0	28,0	32
BF2112-12BSPXF45	BF21.3042.1212	12	3/4"	3/4"-14	67,8	29,0	32
BF2112-16BSPXF45	BF21.3042.1216	12	3/4"	1"-11	72,6	27,5	38
BF2116-16BSPXF45	BF21.3042.1616	16	1"	1"-11	83,7	33,8	38

MATERIAL: Carbon Steel

FINISH: Chromium-(VI) Free plating /
ROHS compliant

Suitable to be used on medium and high pressure braided hoses:

FORZA UNO R1AT/1SN; FORZA UNO "SHARK SKIN" R1AT/1SN; FORZA UNO TROPIC R1AT/1SN; FORZA DUE R2AT/2SN; FORZA DUE "SHARK SKIN" R2AT/2SN; FORZA DUE TROPIC R2AT/2SN; BALPAC PREMIUM R16/2SC; BALPAC PREMIUM "SHARK SKIN" R16/2SC; BALPAC PREMIUM TROPIC R16/2SC; IMPACTUS 5K; IMPACTUS 6K; BALPAC 3000 R17/1SC; BALPAC 3000 "SHARK SKIN" R17/1SC; 2-MAX JACK; BALWASH 1W; BALWASH 2W



BSP 60° Swivel 90° Elbow Female - BSPXF90

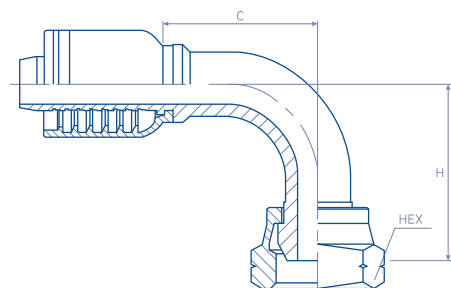

BF21.3092.

ISO 12151-6 / ISO 8434-6

REFERENCE	#	hose		thread	dimensions		
		dash	inch		C - Cut Off	H	HEX
BF2104-02BSPXF90	BF21.3092.0402	04	1/4"	1/8"-28	27,5	27,0	14
BF2104-04BSPXF90	BF21.3092.0404	04	1/4"	1/4"-19	27,6	28,0	19
BF2104-06BSPXF90	BF21.3092.0406	04	1/4"	3/8"-19	30,0	31,0	22
BF2106-06BSPXF90	BF21.3092.0606	06	3/8"	3/8"-19	34,2	31,7	22
BF2106-08BSPXF90	BF21.3092.0608	06	3/8"	1/2"-14	32,7	36,5	27
BF2108-08BSPXF90	BF21.3092.0808	08	1/2"	1/2"-14	41,0	40,0	27
BF2108-10BSPXF90	BF21.3092.0810	08	1/2"	5/8"-14	46,5	46,0	27
BF2110-10BSPXF90	BF21.3092.1010	10	5/8"	5/8"-14	54,0	50,0	27
BF2110-12BSPXF90	BF21.3092.1012	10	5/8"	3/4"-14	54,0	54,0	32
BF2112-12BSPXF90	BF21.3092.1212	12	3/4"	3/4"-14	56,0	58,0	32
BF2112-16BSPXF90	BF21.3092.1216	12	3/4"	1"-11	60,0	62,0	38
BF2116-16BSPXF90	BF21.3092.1616	16	1"	1"-11	71,5	71,0	38

MATERIAL: Carbon Steel

FINISH: Chromium-(VI) Free plating /
ROHS compliant

Suitable to be used on medium and high pressure braided hoses:

FORZA UNO R1AT/1SN; FORZA UNO "SHARK SKIN" R1AT/1SN; FORZA UNO TROPIC R1AT/1SN; FORZA DUE R2AT/2SN; FORZA DUE "SHARK SKIN" R2AT/2SN; FORZA DUE TROPIC R2AT/2SN; BALPAC PREMIUM R16/2SC; BALPAC PREMIUM "SHARK SKIN" R16/2SC; BALPAC PREMIUM TROPIC R16/2SC; IMPACTUS 5K; IMPACTUS 6K; BALPAC 3000 R17/1SC; BALPAC 3000 "SHARK SKIN" R17/1SC; 2-MAX JACK; BALWASH 1W; BALWASH 2W

BSP 60° Male - BSPM

BF21.0100.

ISO 12151-6 / ISO 8434-6

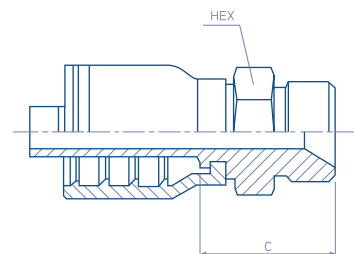

REFERENCE	#	hose		thread	dimensions	
		dash	inch		C - Cut Off	HEX
BF2104-02BSPM	BF21.0100.0402	04	1/4"	1/8"-28	24,2	14
BF2104-04BSPM	BF21.0100.0404	04	1/4"	1/4"-19	28,2	19
BF2104-06BSPM	BF21.0100.0406	04	1/4"	3/8"-19	30,7	22
BF2104-08BSPM	BF21.0100.0408	04	1/4"	1/2"-14	35,2	27
BF2106-04BSPM	BF21.0100.0604	06	3/8"	1/4"-19	26,2	19
BF2106-06BSPM	BF21.0100.0606	06	3/8"	3/8"-19	28,7	22
BF2106-08BSPM	BF21.0100.0608	06	3/8"	1/2"-14	33,2	27
BF2108-06BSPM	BF21.0100.0806	08	1/2"	3/8"-19	30,5	22
BF2108-08BSPM	BF21.0100.0808	08	1/2"	1/2"-14	34,5	27
BF2108-10BSPM	BF21.0100.0810	08	1/2"	5/8"-14	37,5	30
BF2108-12BSPM	BF21.0100.0812	08	1/2"	3/4"-14	40,5	32
BF2110-08BSPM	BF21.0100.1008	10	5/8"	1/2"-14	36,5	27

MATERIAL: Carbon Steel

FINISH: Chromium-(VI) Free plating /
ROHS compliant

Suitable to be used on medium and high pressure braided hoses:

FORZA UNO R1AT/1SN; FORZA UNO "SHARK SKIN" R1AT/1SN; FORZA UNO TROPIC R1AT/1SN; FORZA DUE R2AT/2SN; FORZA DUE "SHARK SKIN" R2AT/2SN; FORZA DUE TROPIC R2AT/2SN; BALPAC PREMIUM R16/2SC; BALPAC PREMIUM "SHARK SKIN" R16/2SC; BALPAC PREMIUM TROPIC R16/2SC; IMPACTUS 5K; IMPACTUS 6K; BALPAC 3000 R17/1SC; BALPAC 3000 "SHARK SKIN" R17/1SC; 2-MAX JACK; BALWASH 1W; BALWASH 2W

PRODUCTS LIMITED WARRANTY

The products sold by Balflex® are warranted to our customers to be free from defects in material and workmanship when shipment at Balflex® warehouses takes place.

All warranty claims shall be made present in writing to Balflex®. Balflex® liability hereunder is limited to the purchase price of the merchandise proving to be defective or, at balflex sole discretion, to the replacement of such merchandise upon its authorized return to Balflex®.

This warranty is in lieu of and excludes all other warranties, or conditions expressed, implied, statutory or otherwise created under applicable law including, but not limited to the warranty of merchantability and the warranty of fitness for a particular purpose.

In addition, this warranty shall not apply and will be null and void to any products or portions thereof that have been subject to abuse, misuse, improper installation, maintenance or operation, electrical failure or abnormal conditions and to products that have been tampered with, altered, modified, repaired, reworked by anyone not approved by balflex or used in any other manner inconsistent with any Balflex® instructions or specifications. Balflex® disclaims any liability for any hose assemblies which have not been produced with in conformance with Balflex® assembly recommendations and parts.

In no event shall balflex have any liability whatsoever to any person, including without limitation, any immediate buyer, purchaser or other third party, for any special, punitive, incidental or consequential damages, including without limitation, profit loss or customer loss, loss or damage to physical property of customer or any other person and loss of anticipated revenue, profits, goodwill, savings or other economic loss of customer or any other person.

Specification subject to change without prior notice.
Errors and omission excluded.



U.S.A. and Canada

6000 South Loop East Freeway
Houston, Tx 77033
United States of America
Tel: (1) 713-928-6064
Email: sales@balflex.com
www.balflexusa.com

Europe Headquarters

R. Bouça dos Estilhadouros, 226/254
4445-044 Alfena, Portugal
Tel: (351) 229 698 160
Email: balflex@balflex.com
www.balflex.com

Germany

Franckensteinstraße 8
77749 Hohberg
Tel: (49) 07808 4318857
Email: info@2bhydraulik.de
www.balflex.com

South America

R. Padre Cesari Lelli, 1014
Rodovia BR-116
CEP 83420-000 Quatro Barras/PR
Brasil
Tel: (55) 41 3671 3450
Email: comercial@balflex.com.br
www.balflex.com

www.balflex.com

An ISO 9001:2015 Company:



Cofinanciado por:



UNIÃO EUROPEIA
Fundo Europeu
de Desenvolvimento Regional

